

PV-SIGMA Compact

Spectrum-series, DN15-DN50

Application

PV-SIGMA Compact Spectrum-series can be installed in domestic and commercial heating and cooling systems.

The PV-SIGMA Compact Spectrum-series combines the SIGMA Compact dynamic balancing valve positioned in the flow and the PV Compact Spectrum-series differential pressure control valve positioned in the return.

The Frese PV-SIGMA Compact Spectrum-series system ensures 100% flow and differential pressure regulation under all conditions, irrespective of any changes within the system whilst providing simple and trouble free commissioning.

The Frese PV-SIGMA Compact Spectrum-series system operates by limiting the flow and pressure in a system, and thereby ensures the correct energy consumption at the same time as it eliminates the risk of noise caused by excess differential pressure.

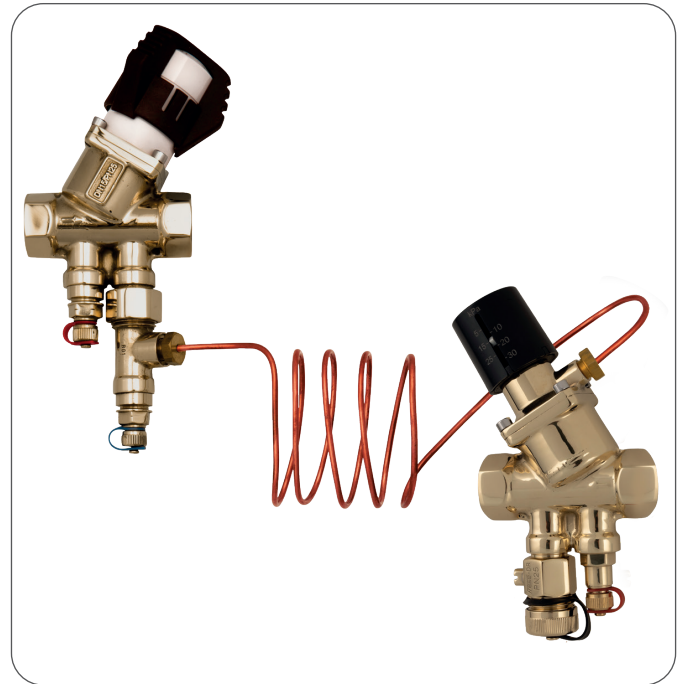

Benefits

- Simple presetting of flow and differential pressure
- High Kv value that achieves a low pressure loss and increased energy efficiency
- Positive close off to prevent rising differential pressure when control valves in the controlled circuit are fully closed
- Flow and differential pressure can be adjusted independently of each other
- Tamper-proof presetting device on top of the valve, meaning there is no need for valve sealing after presetting
- Differential pressure can be set and adjusted on site
- Simple presetting using the scale on the cap
- The PV Compact Spectrum-series eliminates noise caused by high differential pressure whilst the SIGMA Compact limits the flow in a system, ensuring no overflows

Features

- Size range: DN15 to DN50
- Maximum flow: 10350 l/h
- Maximum differential pressure 400 kPa
- Setting ranges: 5-30 kPa, 20-60 kPa and 20-80 kPa
- Differential pressure regulation, flow regulation, drain and PT plugs as standard
- Isolation in the flow direction on the SIGMA Compact according to EN1349 Class IV
- Isolation in the return flow using the supplied ball valve
- Compact housings for easy installation

PV-SIGMA Compact

Spectrum-series, DN15-DN50

Design PV-SIGMA Compact

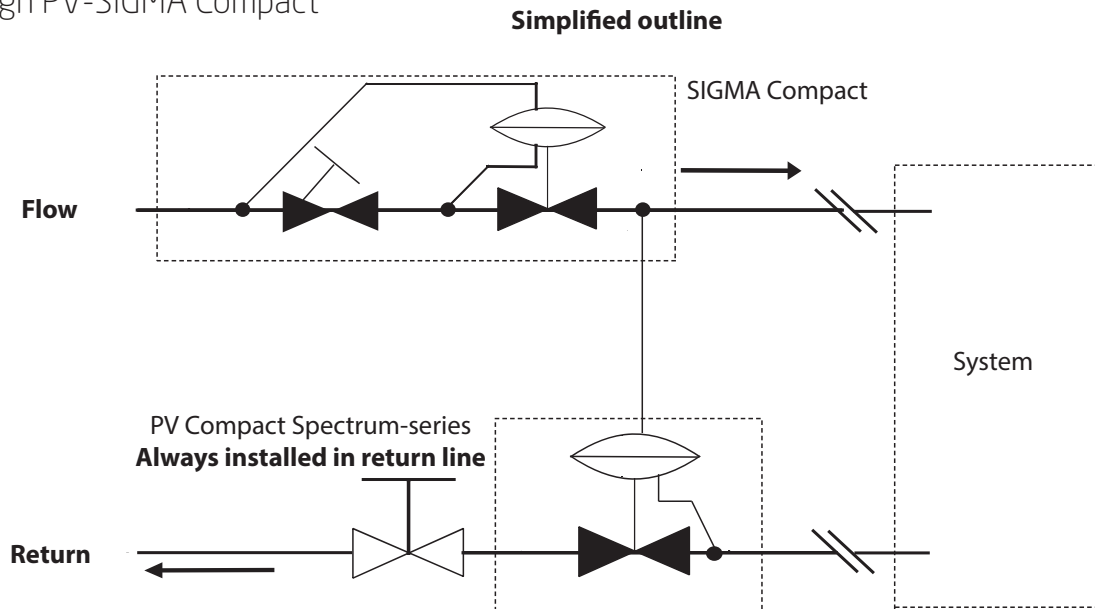

Measurement of differential pressure across the system

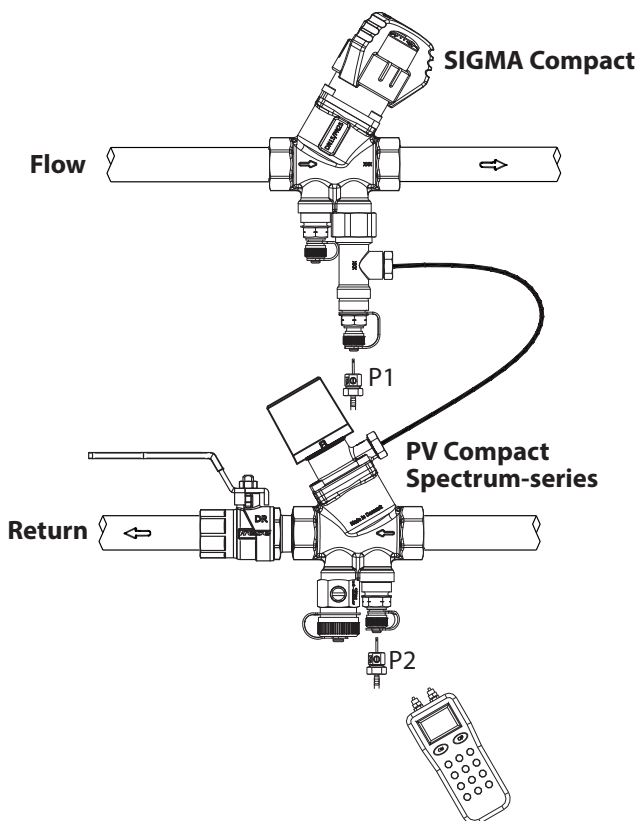

Design flow: The flow limitation is adjusted directly on SIGMA Compact (See Technote for SIGMA Compact or use the Frese APP)

Differential pressure : ΔP_s is adjusted directly on the scale of PV Compact Spectrum-series (See Technote for PV Compact Spectrum-series)

The differential pressure of the system (ΔP_s) is measured from P1 to P2

PV-SIGMA Compact

Spectrum-series, DN15-DN50

Technical data

Housing DN15-32:	DZR Brass, CW602N
DN40-50	Ductile Iron
DP controller:	PPS (40% glass)
Flow setting:	PA6 (20% glass)
Spring:	Stainless steel
Diaphragm:	HNBR
O-rings:	EPDM
Pressure class:	PN25 (PV+SIGMA) PN16 (Ball valve)
Max. differential pressure:	400 kPa
Temperature range:	-10°C to + 120°C
Capillary tube:	Ø3, L = 1000 mm

The pipe system shall be properly ventilated to avoid risk of air pockets. Glycolic mixtures up to 50% are applicable (both ethylene and propylene).
Recommendation: Water treatment to VDI 2035.

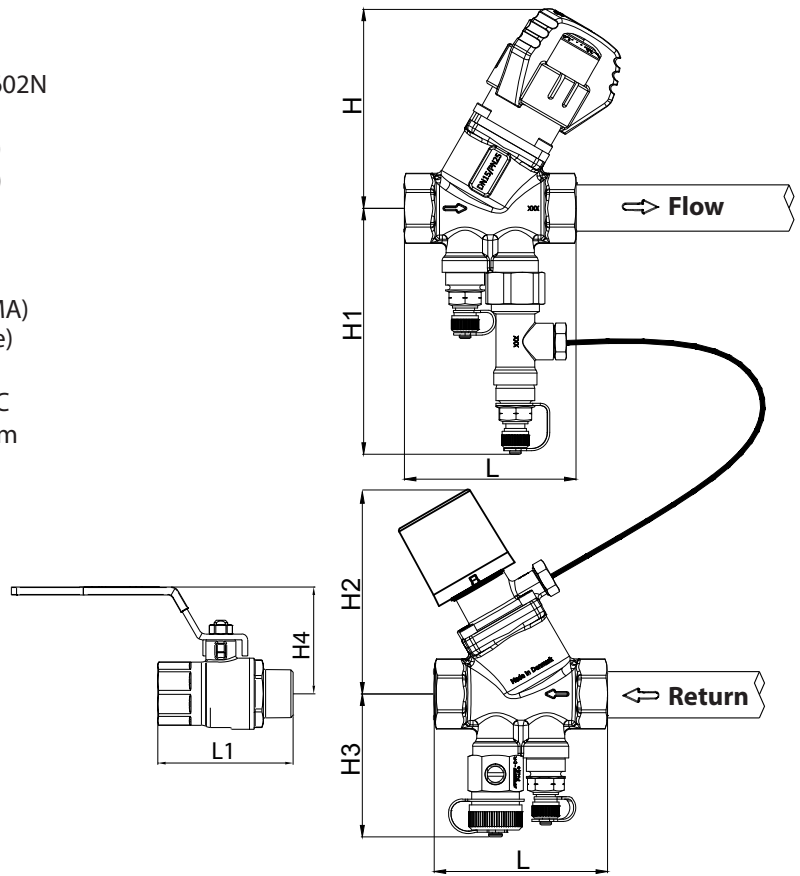

PV-SIGMA Compact Spectrum-series

Dimension		DN15		DN20		DN25		DN32	DN40	DN50
Version		Low	High	Low	High	Low	High	-	-	-
Control range	kPa	5-30	20-60	5-30	20-60	5-30	20-80	20-80	20-80	20-80
Flow range	l/s	0.014-0.167	0.028-0.278	0.028-0.278	0.042-0.536	0.167-0.583	0.208-0.667	0.278-1.389	0.833-2.056	1.389-2.875
	l/h	50-600	100-1000	100-1000	150-1930	600-2100	750-2400	1000-5000	3000-7400	5000-10350
	gpm	0.22-2.64	0.44-4.40	0.44-4.40	0.66-8.50	2.64-9.25	3.30-10.56	4.40-22.01	13.21-32.58	22.01-45.57
Dimension mm	L	75		79		78	78/100	104	138	138
	L1	60		66		78		96	103	125
	H	87		87		90	90	110	131	131
	H1	108		108		108	108	119	121	127
	H2	87		87		90	142	142	161	161
	H3	66		66		68	72	77	80	86
	H4	44		47		55		75	82	94



PV-SIGMA Compact

Spectrum-series, DN15-DN50

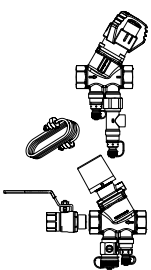
Product programme

	Dimension	DN15	DN20	DN25	DN32	DN40	DN50
PV-SIGMA Compact Spectrum-series with drain valve, P/T plugs, isolation ball valve and capillary tube.		53-3270	53-3272	53-3274	53-3276	53-3277	53-3278
		Low 5-30 kPa	Low 5-30 kPa	Low 5-30 kPa			
		53-3271	53-3273	53-3275	20-80 kPa	Low 20-80 kPa	Low 20-80 kPa
		High 20-60 kPa	High 20-60 kPa	High 20-80 kPa			

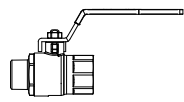
Accessories

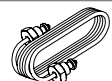
	Female/Male	Dimensions	Frese no.
Isolation ball valve		DN15	38-5020
		DN20	38-5022
		DN25	38-5024
		DN32	38-5026
		DN40	38-5028
		DN50	38-5030
1/2" Female end with P/T-plug		-	48-0017
Capillary tube ø3mm x 1000 mm		-	48-0004

PV-SIGMA Compact

Spectrum-series, DN15-DN50

Example: Pre setting the valves

PV-SIGMA Compact DN15 Low Differential pressure system (ΔP_s) 12 kPa

Design flow 500 l/h (0,139 l/s)

Differential pressure setting PV Compact Spectrum-series

1. The differential pressure is set directly on the scale and the pressure loss across the valve can be found on the graph or in the Frese APP
2. The minimum pressure drop required will be 3.0 kPa across the valve. (ΔP_{v2})

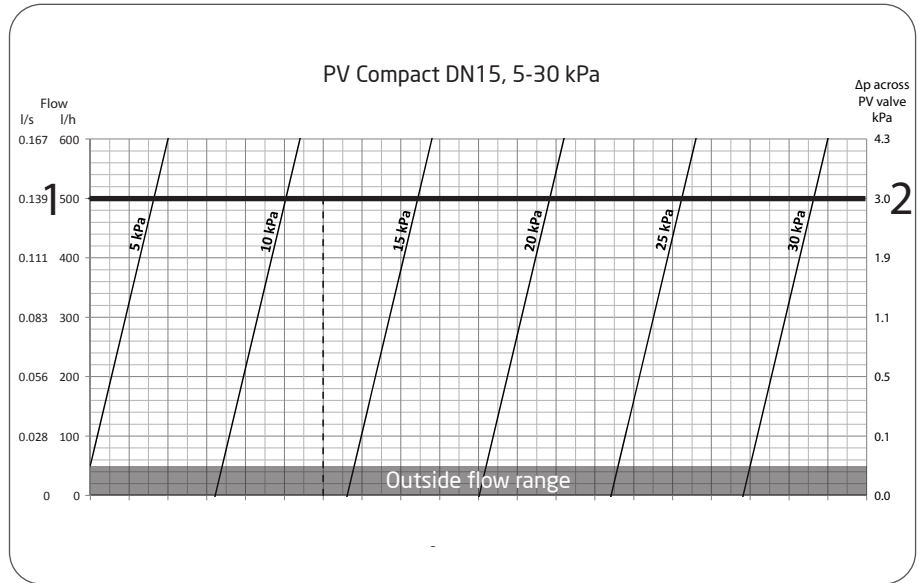

Flow setting SIGMA Compact DN15 Low

Design flow 500 l/h (0,139 l/s)

1. The design flow is used as the point of reference for the setting. (See the graph)
2. The pre-setting for the valve is found by means of the flow rate graph or the Frese APP
Setting = 2.2
3. The minimum differential pressure required will be 11 kPa across the valve. (ΔP_{v1})

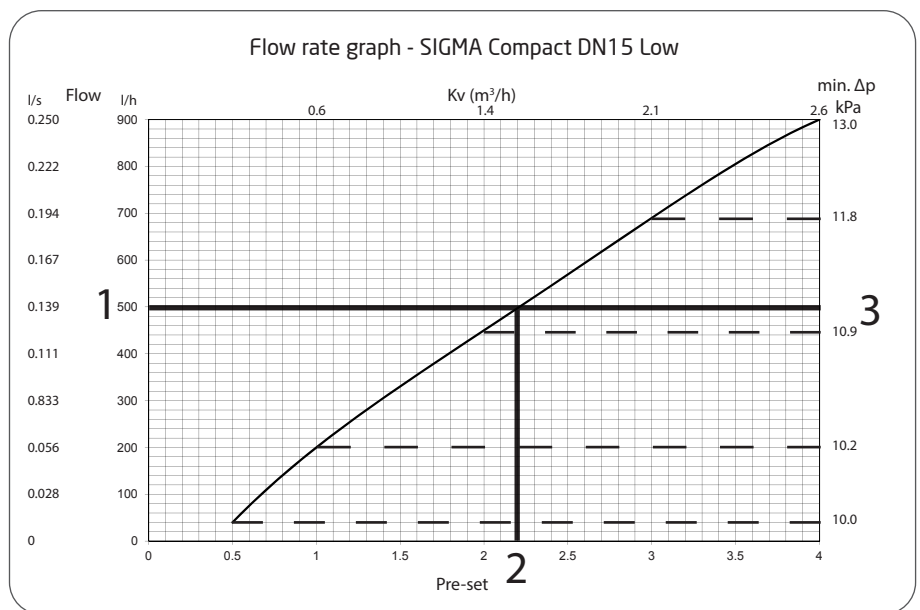

PV-SIGMA Compact

Spectrum-series, DN15-DN50

Example: Outline of a heating system - 3 blocks with 3 flats in each

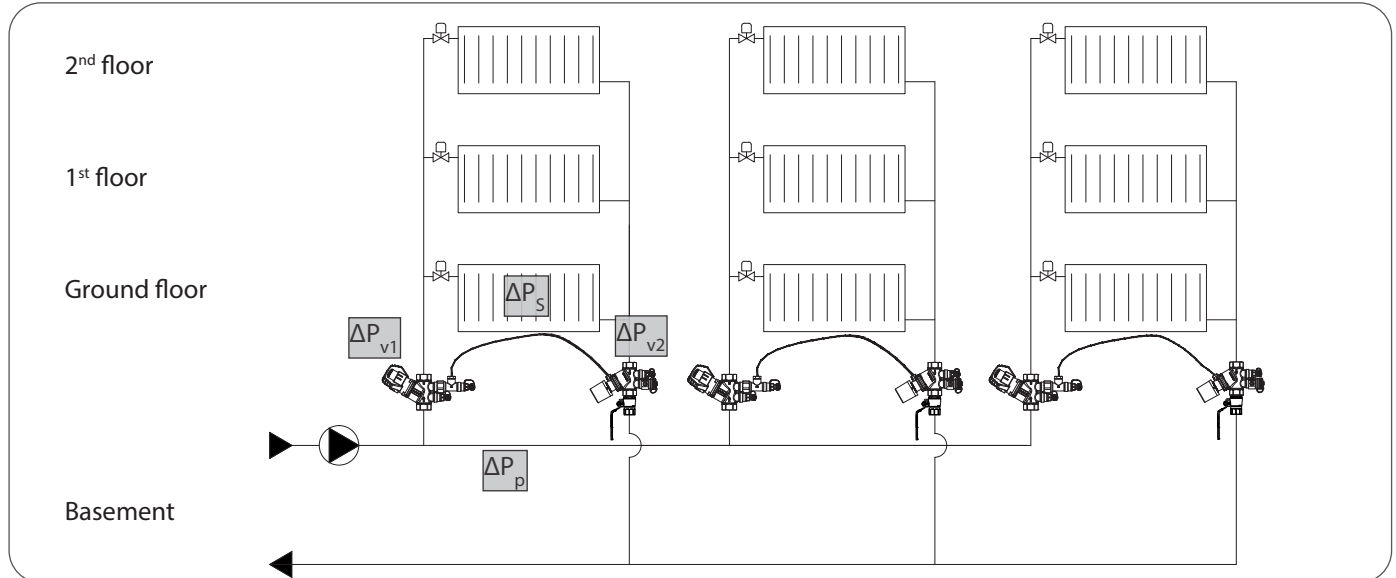

Total pump pressure

Based on the examples on the previous pages and assuming there are three identical risers in the building, the total required pump pressure for each riser can now be calculated:

$$\Delta P_p = \Delta P_s + (\Delta P_{v1+v2}) \Rightarrow \Delta P_p = 12 \text{ kPa} + (11 \text{ kPa} + 3 \text{ kPa}) = \mathbf{26 \text{ kPa}}$$

PV-SIGMA Compact

Spectrum-series, DN15-DN50

PV Compact DN15, 5-30 kPa

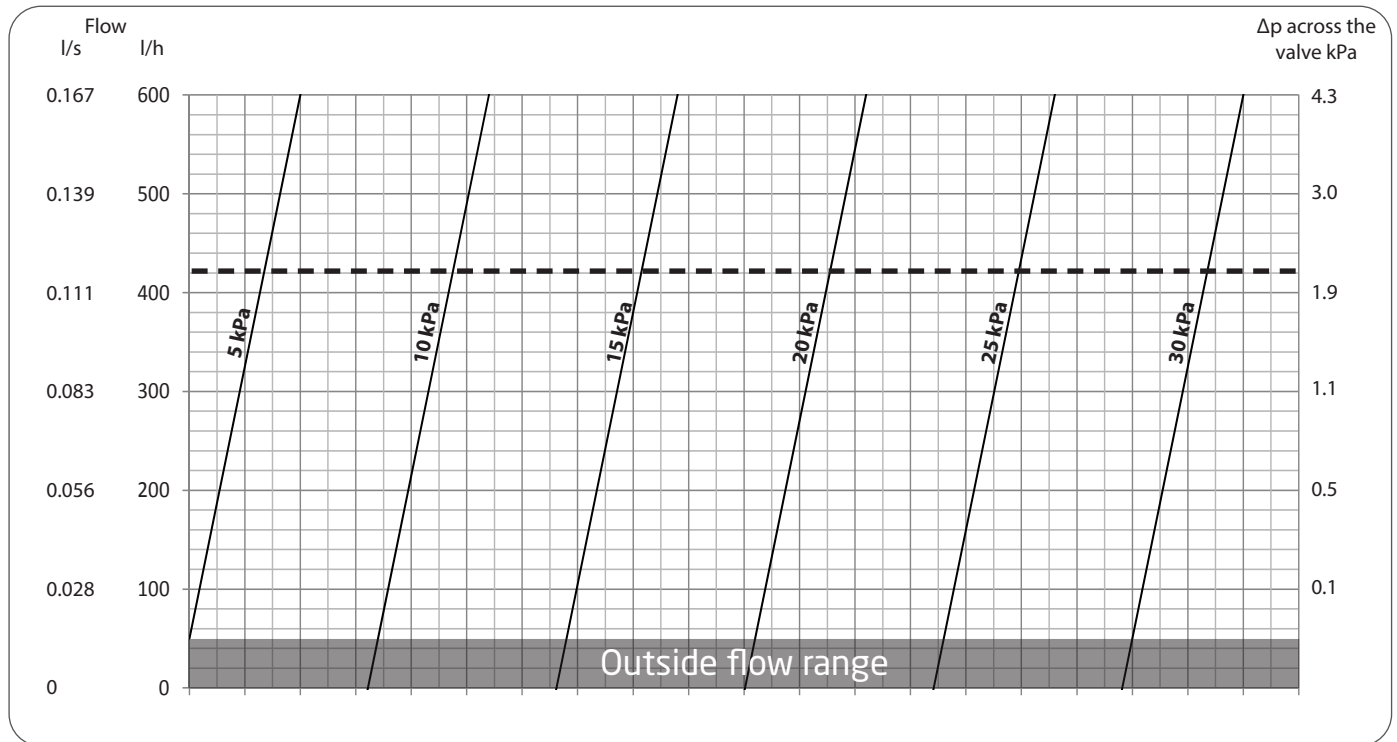

SIGMA Compact DN15 Low

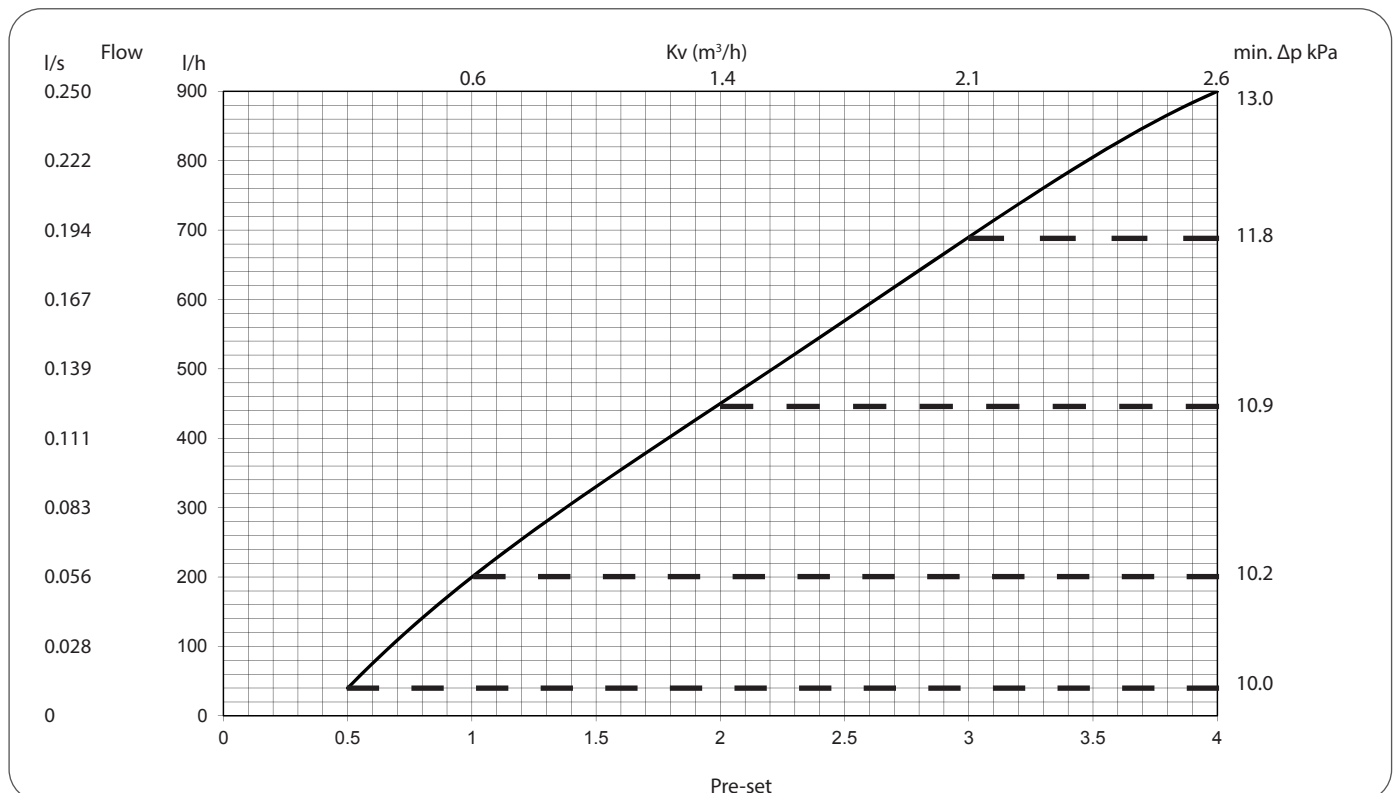

PV-SIGMA Compact

Spectrum-series, DN15-DN50

PV Compact DN15, 20-60 kPa

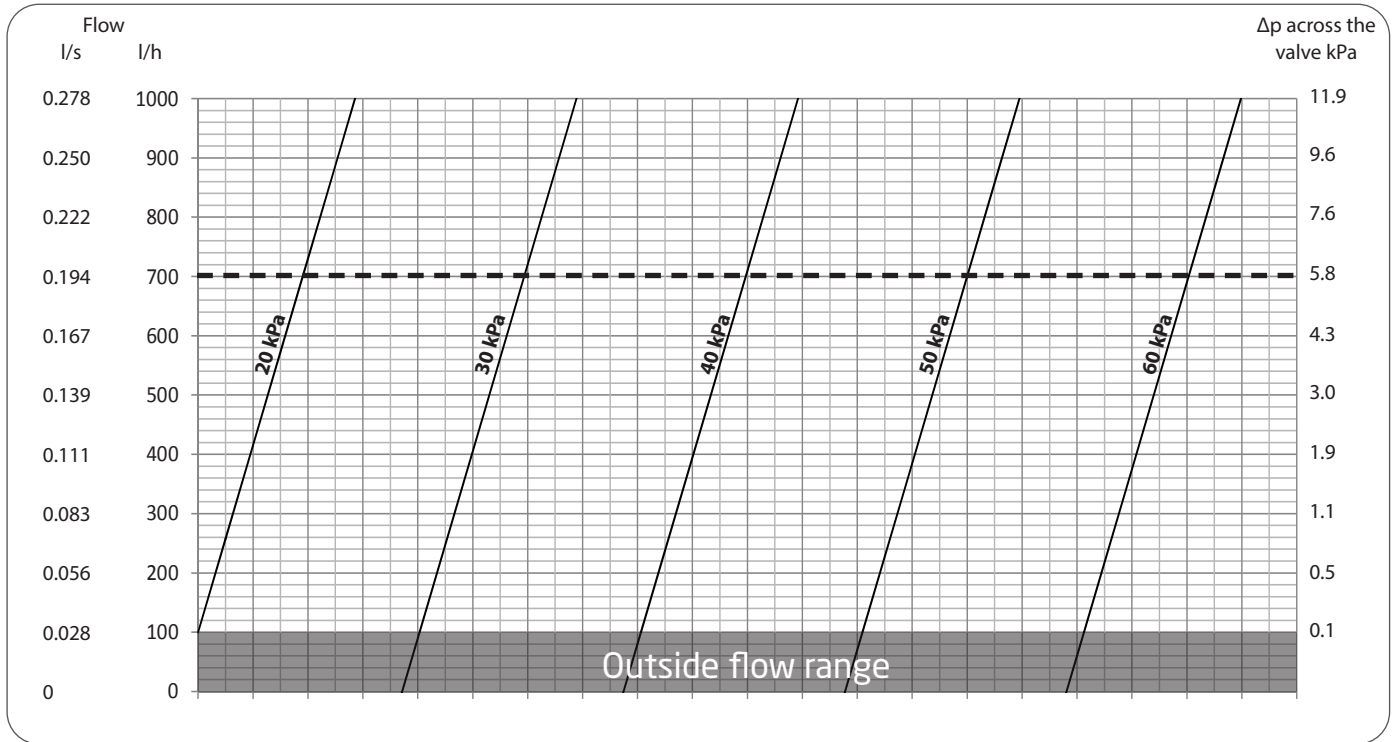

SIGMA Compact DN15 High

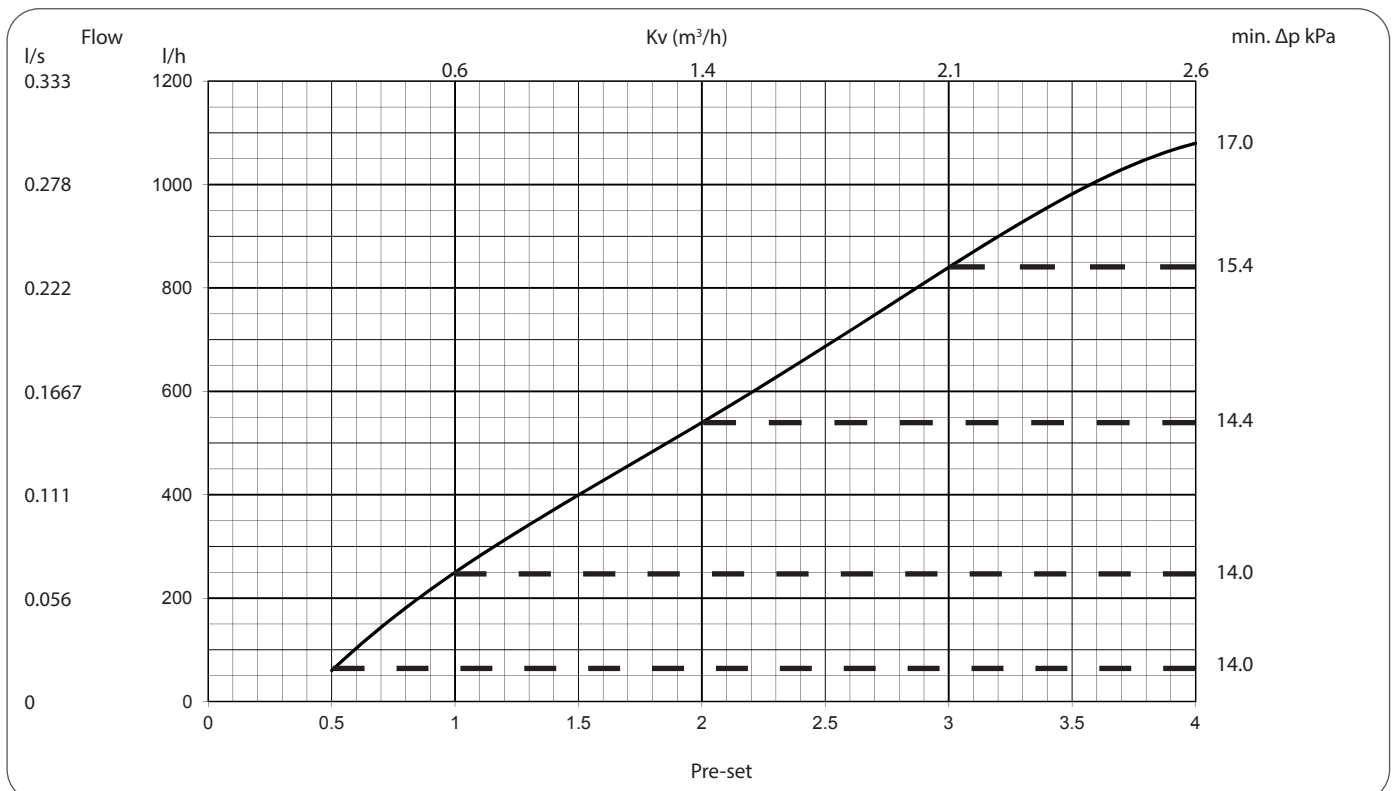

PV-SIGMA Compact

Spectrum-series, DN15-DN50

PV Compact DN20, 5-30 kPa

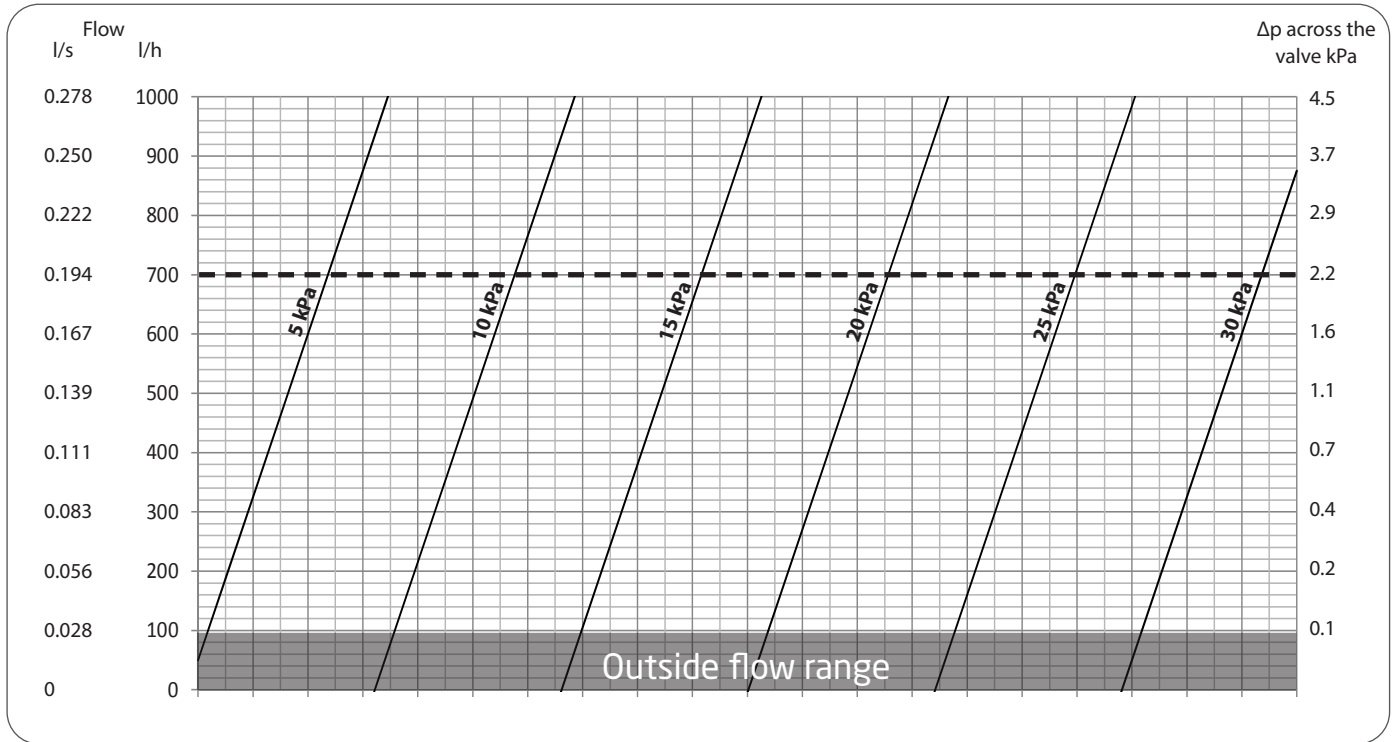

SIGMA Compact DN20 Low

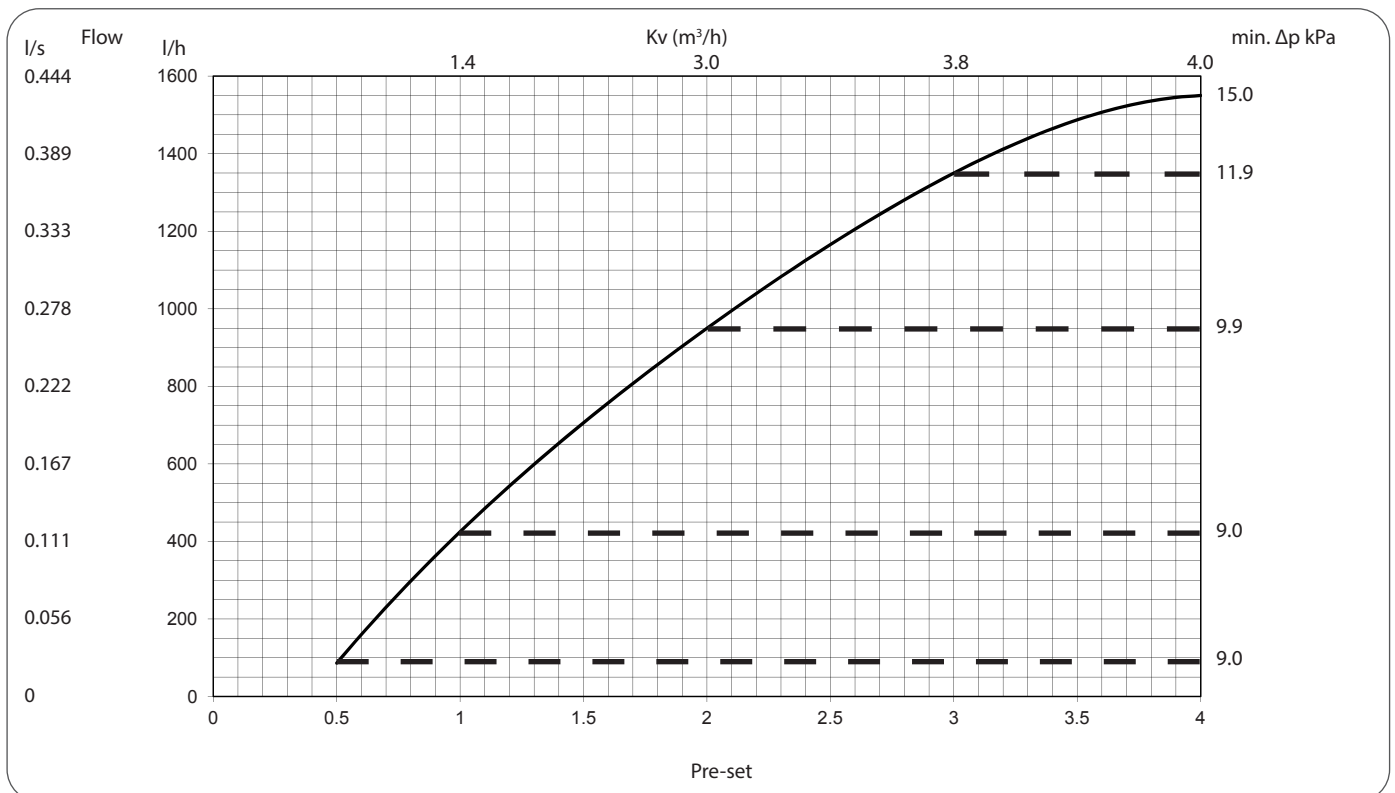

PV-SIGMA Compact

Spectrum-series, DN15-DN50

PV Compact DN20, 20-60 kPa

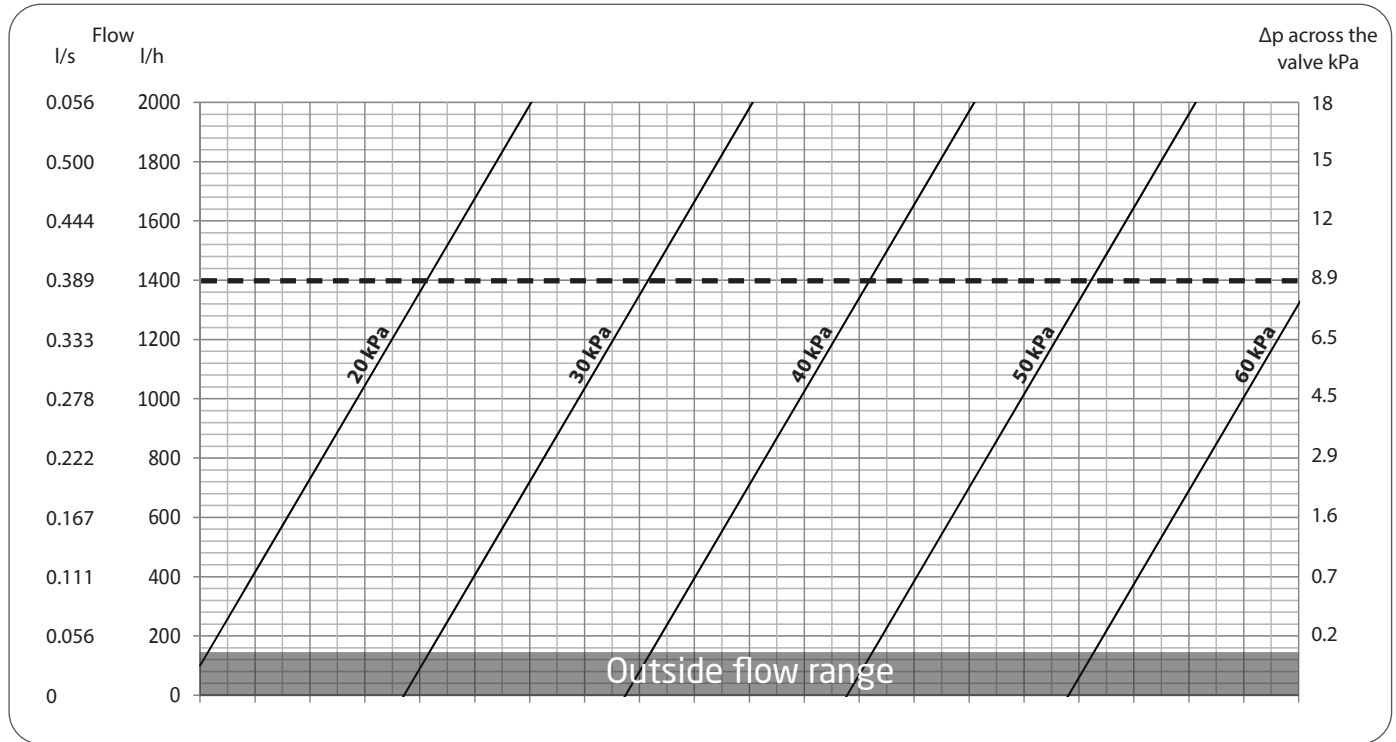

SIGMA Compact DN20 High

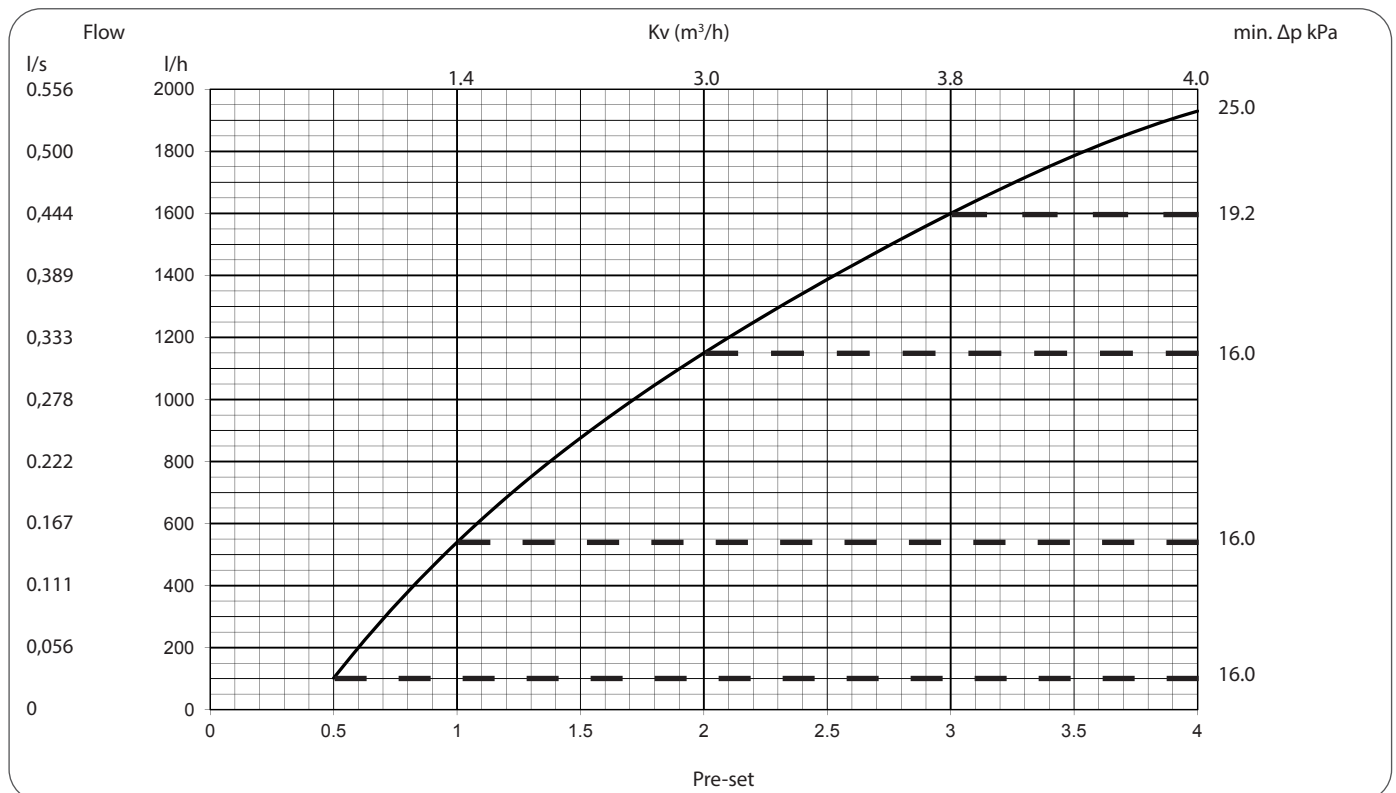

PV-SIGMA Compact

Spectrum-series, DN15-DN50

PV Compact DN25, 5-30 kPa

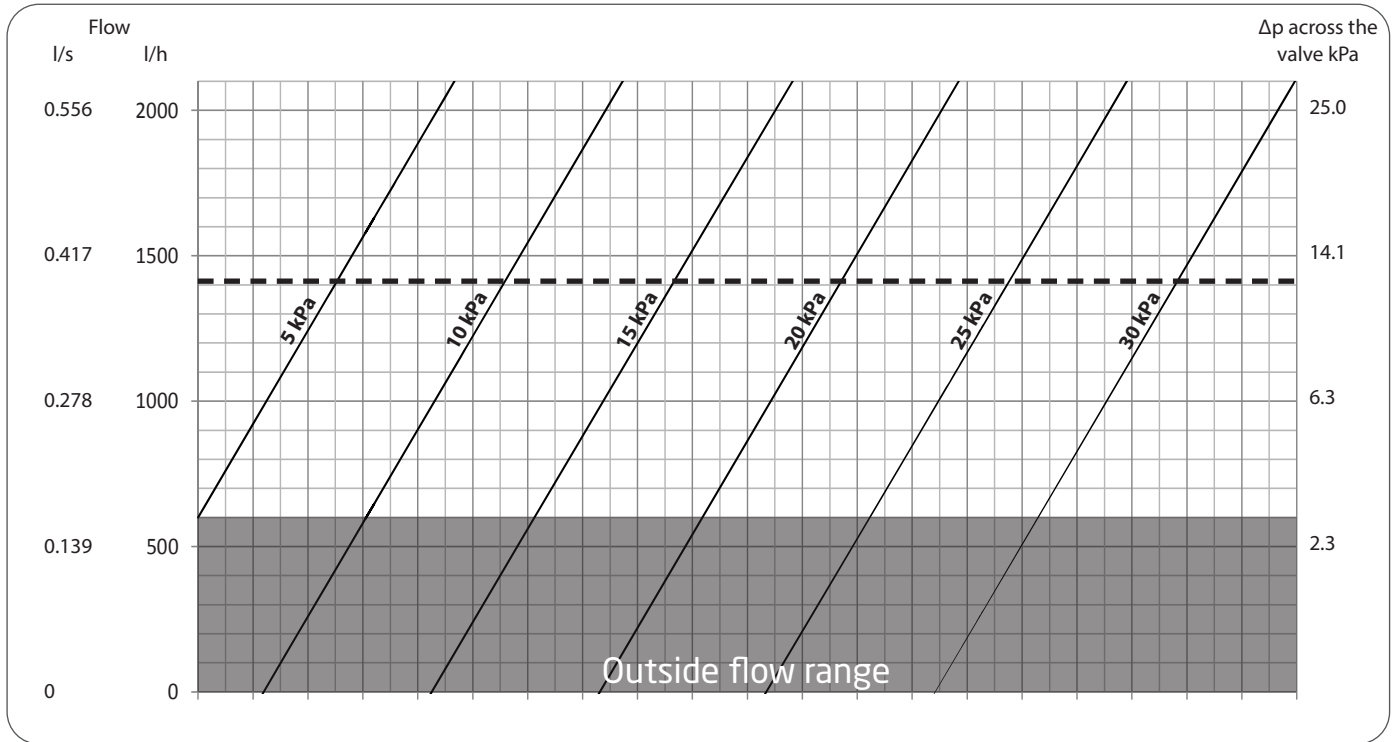

SIGMA Compact DN25 High

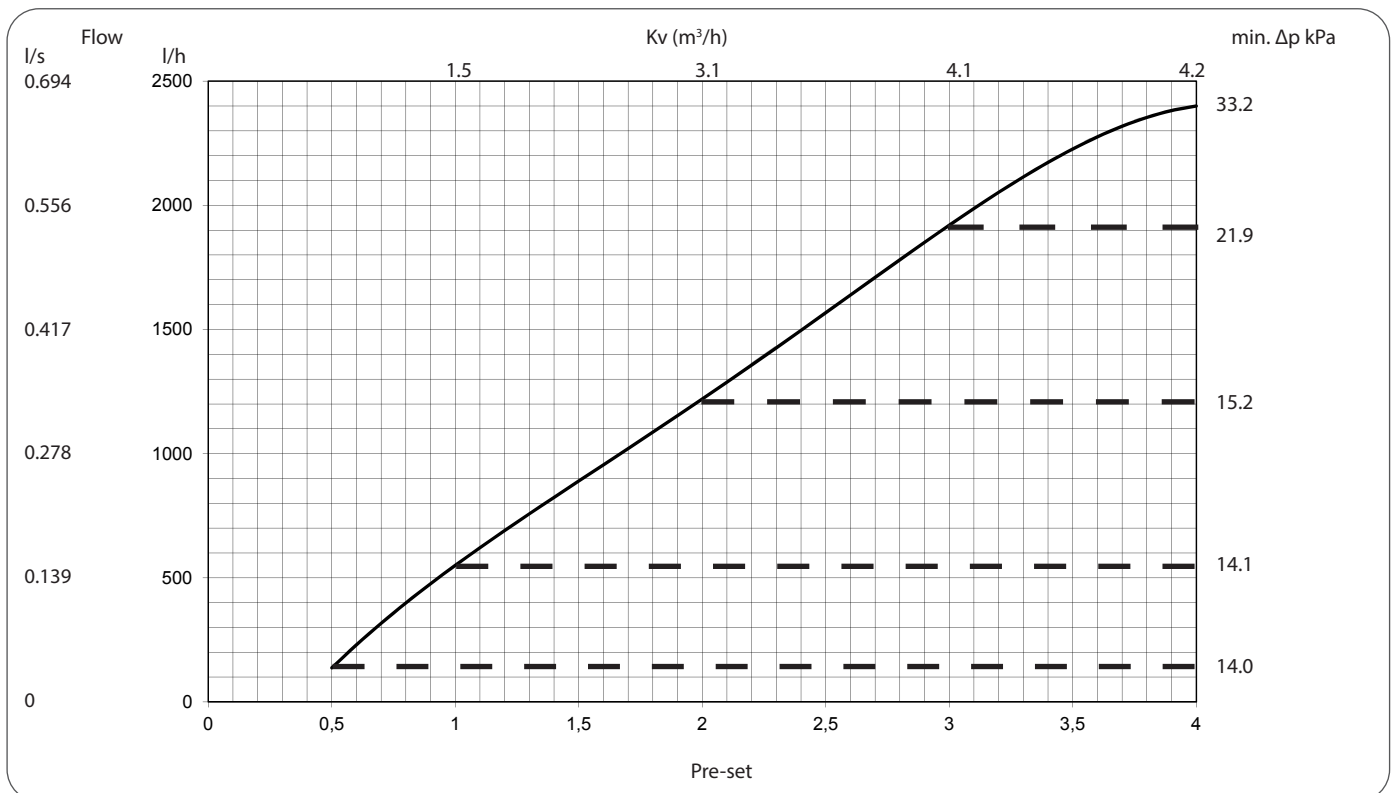

PV-SIGMA Compact

Spectrum-series, DN15-DN50

PV Compact DN25L, 20-80 kPa

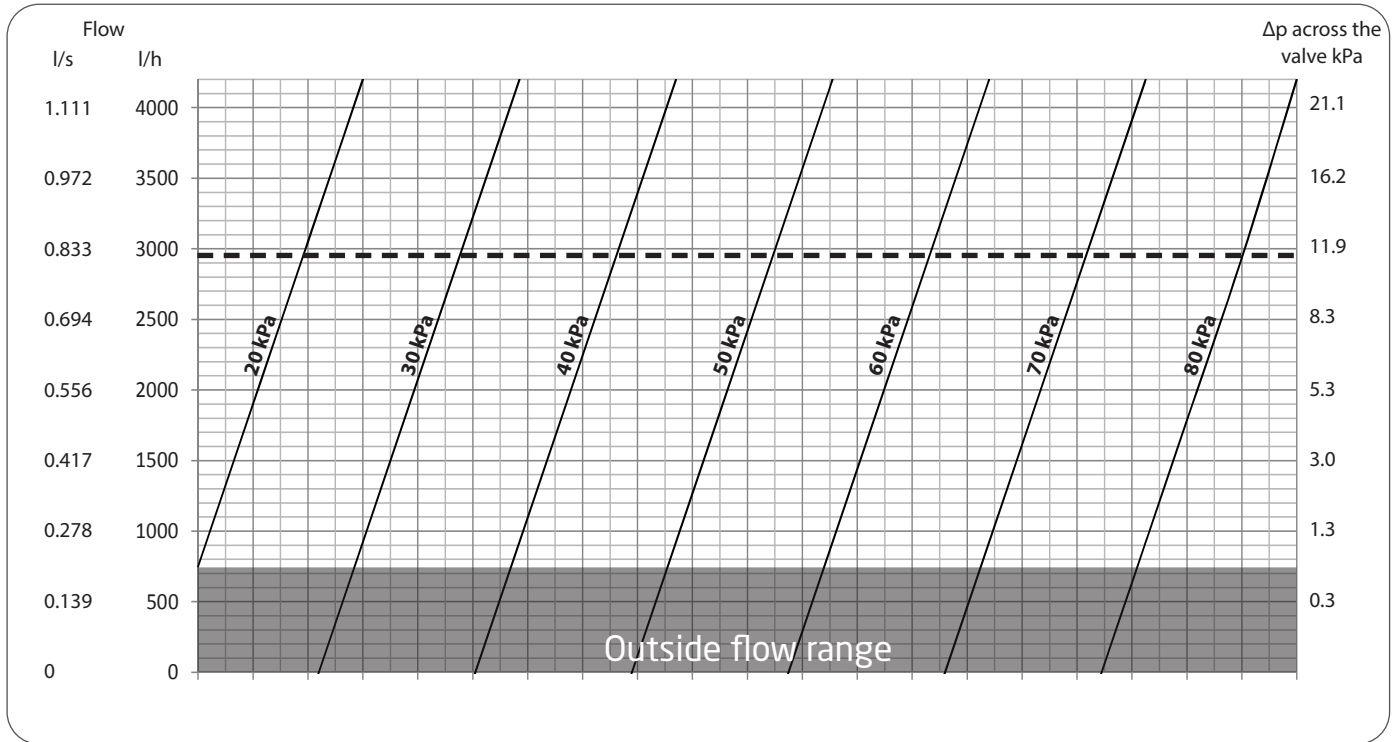

SIGMA Compact DN25 High

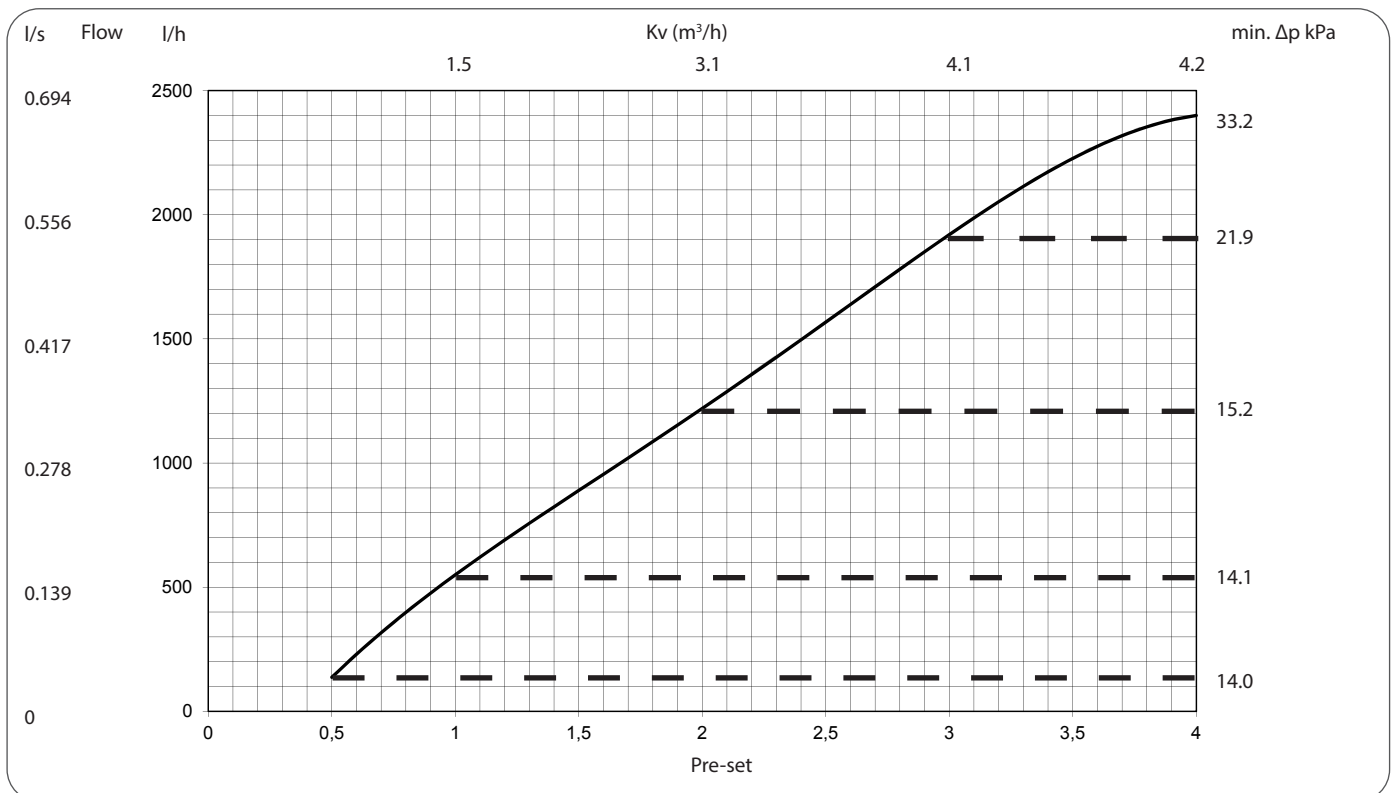

PV-SIGMA Compact

Spectrum-series, DN15-DN50

PV Compact DN32, 20-80 kPa

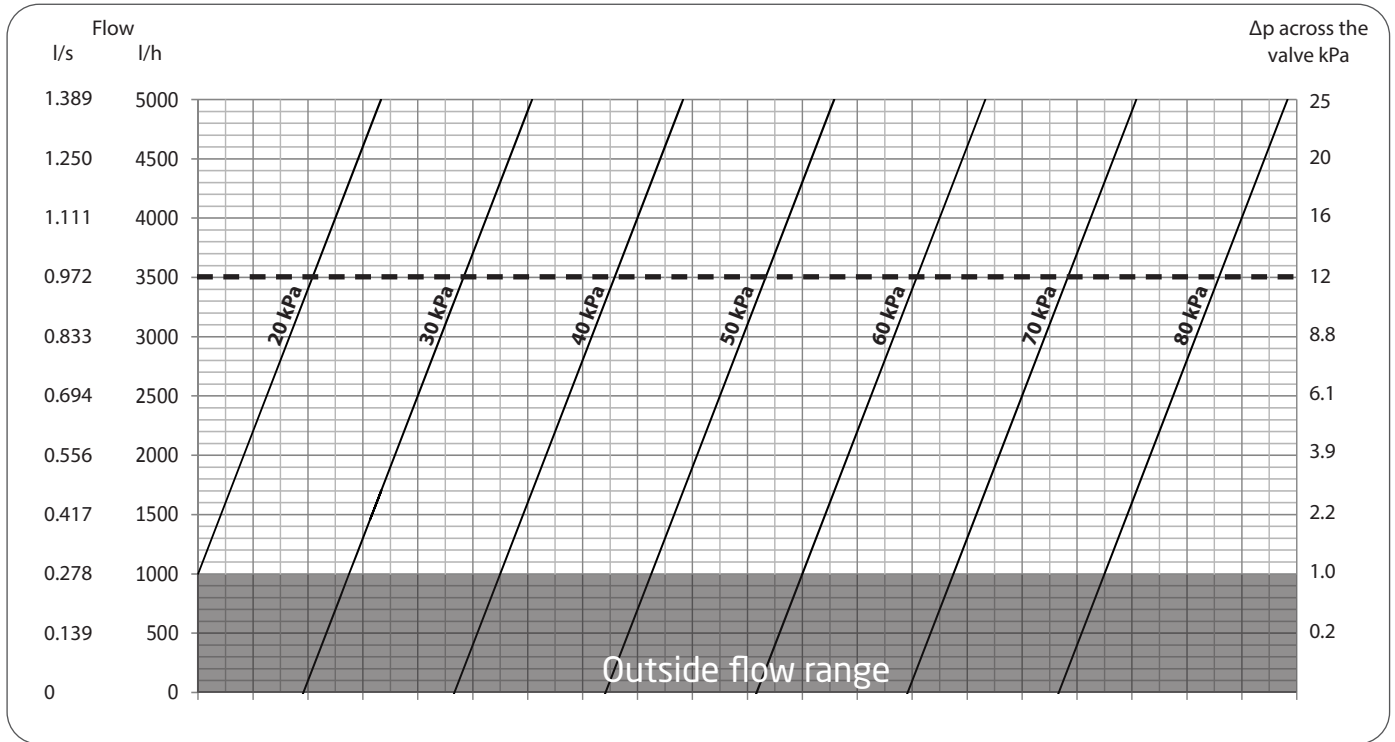

SIGMA Compact DN32

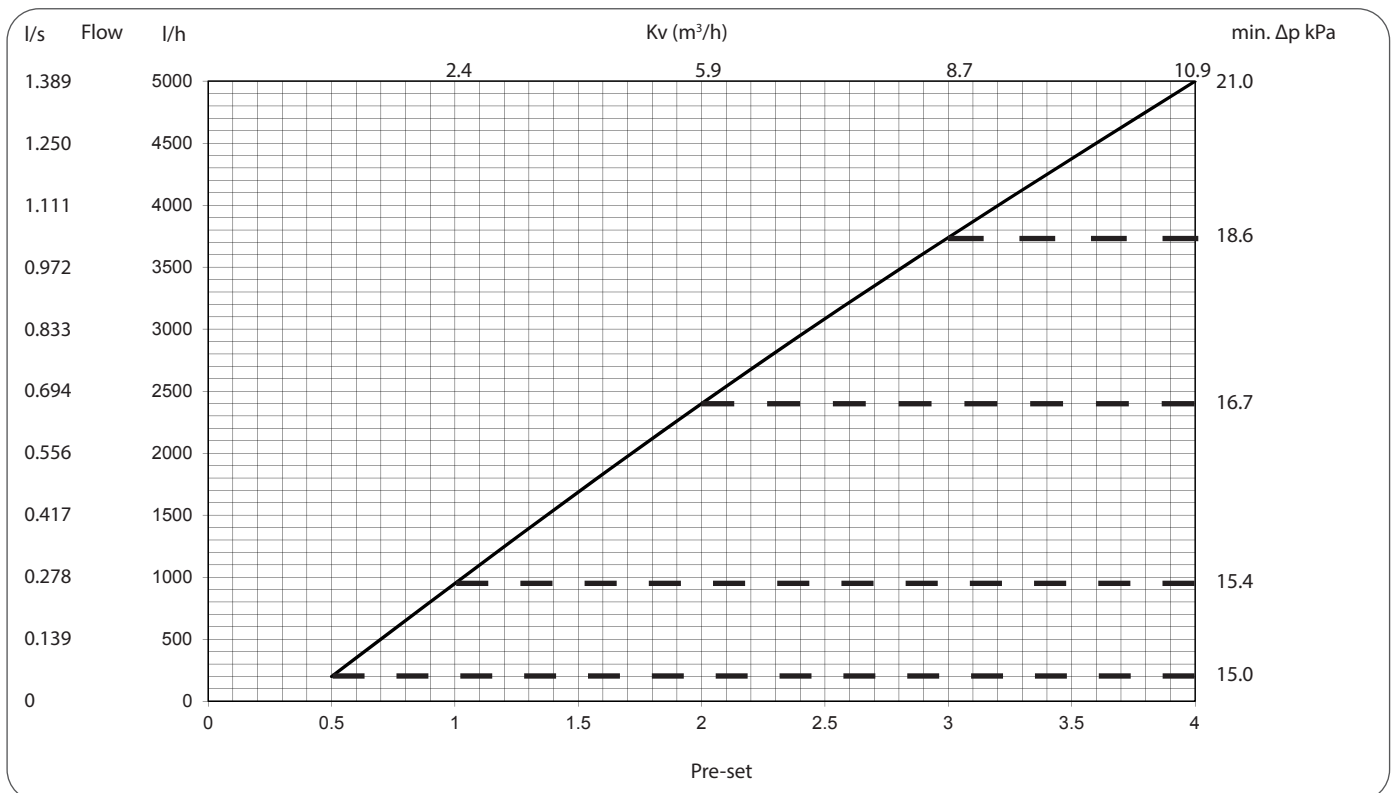

PV-SIGMA Compact

Spectrum-series, DN15-DN50

PV Compact DN40, 20-80 kPa

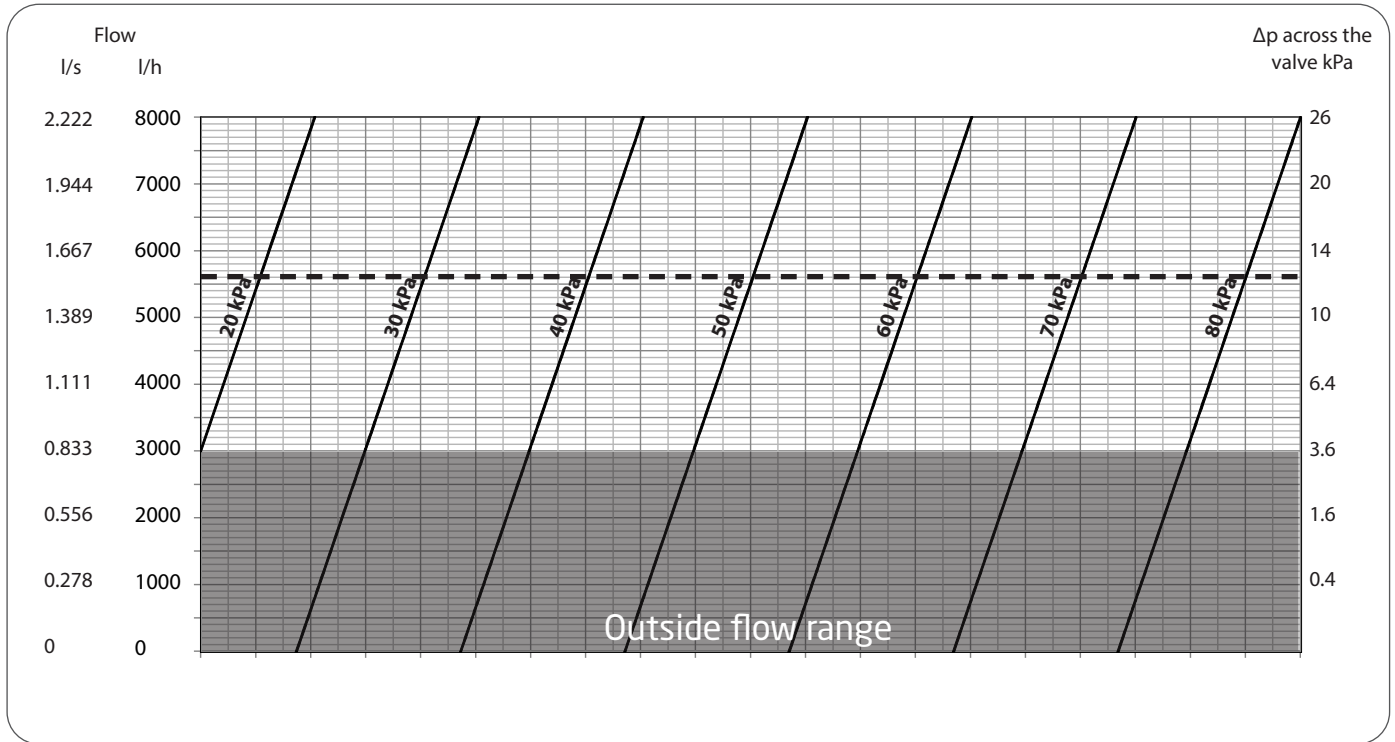

SIGMA Compact DN40

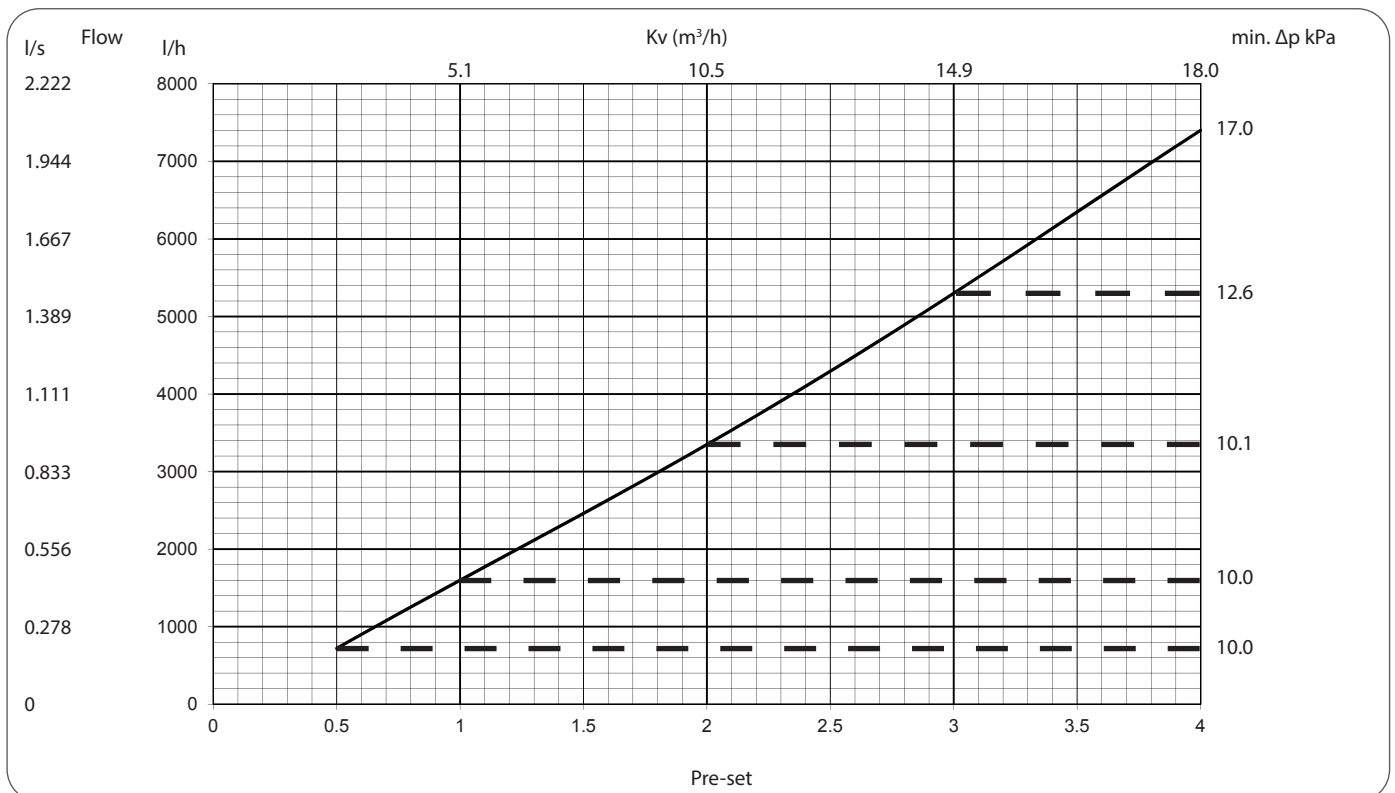

PV-SIGMA Compact

Spectrum-series, DN15-DN50

PV Compact DN50, 20-80 kPa

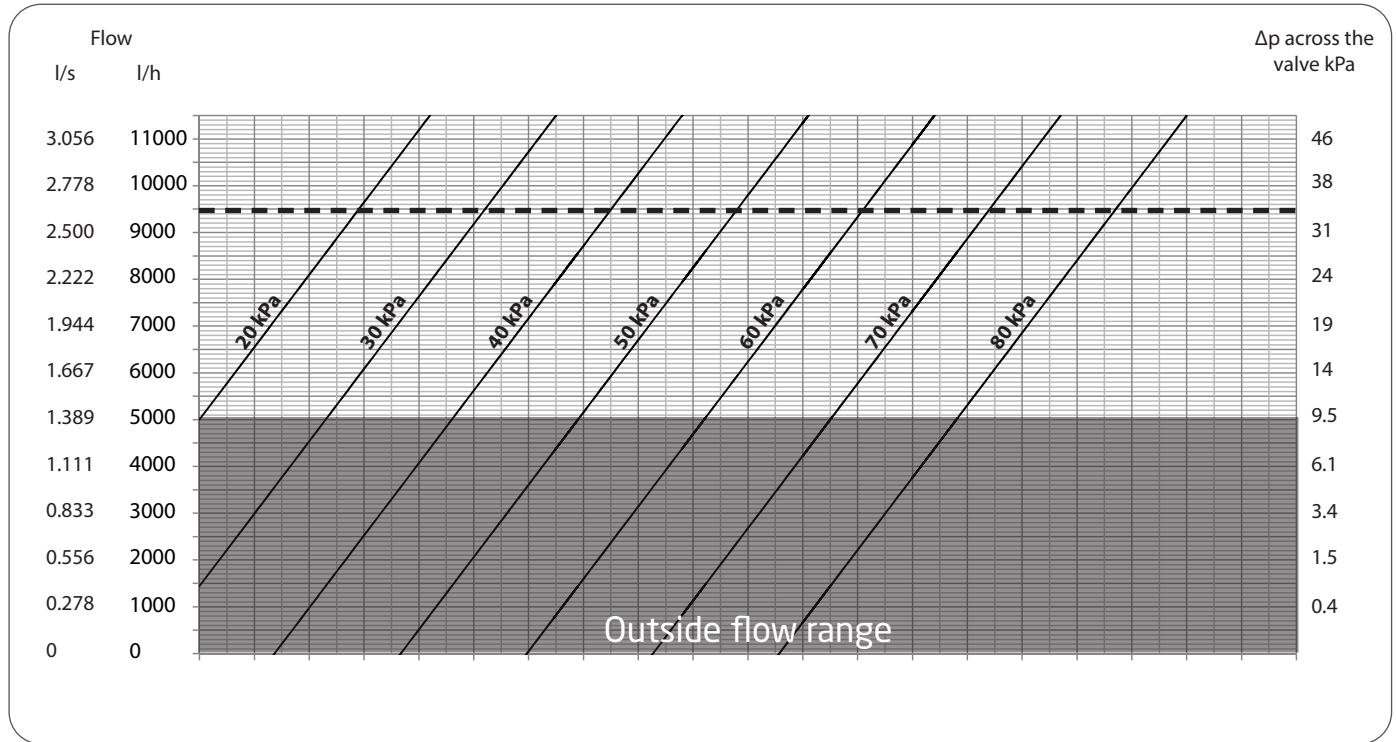

SIGMA Compact DN50

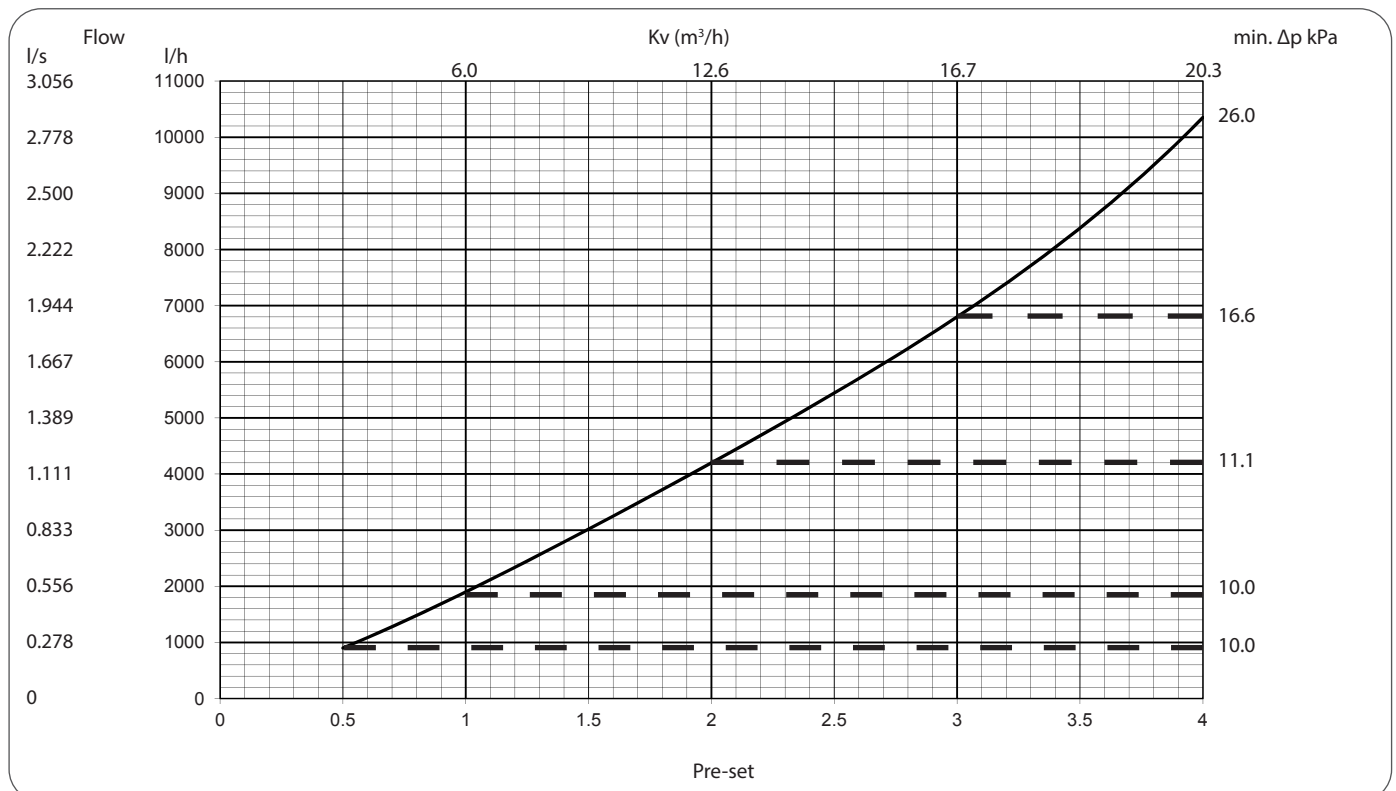

PV-SIGMA Compact

Spectrum-series, DN15-DN50

Specification Text - PV-SIGMA Spectrum-series, Dynamic Pressure & Flow Regulation Set

The valve set shall be a combination of a dynamic differential pressure control valve and an externally adjustable dynamic balancing valve.

The differential pressure and flow shall be adjustable on site without suspension of operation.

The valve set shall limit the flow and differential pressure in a circuit.

The valve set shall include P/T plugs for the verification of differential pressure in circuit and across the valve.

The valve set shall include a drain on the differential pressure control valve.

The differential pressure shall be set by means of a key and following the pointer on the scale.

The dynamic balancing valve shall be adjusted by means of a lockable handle.

The dynamic balancing valve shall be capable of isolation in the flow direction based on EN1349 Class IV leakage tightness.

The valves shall be permanently marked with an indicator for flow direction.

The dynamic pressure and flow regulation set shall have a pressure rating of PN25. (PN16, when a ball valve is used on the return).

The maximum differential pressure shall be 400 kPa.

The valve housing shall be DZR brass CW602N (DN15 to DN32) and Ductile Iron (DN40 to DN50).

The Differential Pressure Control Valve shall have a rubber seat to provide positive close off.

Frese A/S assumes no responsibility for errors, if any, in catalogues, brochures, and other printed matter. Frese A/S reserves the right to modify its products without prior notice, including already ordered products, if this does not alter existing specifications. All registered trademarks in this material are the property of Frese A/S. All rights reserved.

Frese A/S
Tel: +45 58 56 00 00
info@frese.dk