

SIGMA Compact Dynamic Balancing Valve

Description

The SIGMA Compact is an externally adjustable dynamic balancing valve that provides simple, accurate and reliable flow limitation and isolation in heating and cooling systems.

Application

SIGMA Compact can be used in both heating and cooling systems for the effective distribution of flow in various sections of the system.

The Frese SIGMA Compact can be used instead of traditional double regulating valves and can be installed in both variable flow systems and constant flow systems.

Operation

The SIGMA Compact can be set to the required position easily by using the hand wheel to limit the flow rate in certain parts of a system, eradicating overflows and the unnecessary wastage of energy.

The internal differential pressure control function of the SIGMA Compact ensures that the set flow rate is limited irrespective of pressure fluctuations in the system.

Once the valve has been pre-set to the desired flow rate, the hand wheel can be set in position. From this position, the valve can be fully closed for isolation purposes and easily re-opened back to the required set point.

Features

- Easy adjustment of the flow using the hand wheel
- Isolation function according to EN1349 Class IV regardless if higher pressure is on the inlet or on the outlet side of the valve
- Maximum flow position can be set for easy reopening to pre-set flow position, after the valve has been used for isolation
- Clear setting scale located on the hand wheel
- No minimum straight pipe lengths required before or after the valve
- Built-in P/T plugs for needle system



Benefits

- Easy to size and select as only the flow rate is required
- Simplified system design with the number of balancing valves being reduced
- Works as a flow limiter ensuring no overflows
- Easy to install and adjust on site
- Provides flexibility if the system is modified after the initial installation
- Simplifies the commissioning process and reduces commissioning time due to automatic balancing of the system
- High level comfort for the end-users as a result of the correct balance of the hydraulic system
- Reliable operation as a dynamic balancing valve automatically finds the hydraulic balance regardless of pressure fluctuations in the system
- Reduces the number of valves to install as no main circuit or branch balancing valves needed in the system
- No need for straight pipe before and after the valve

SIGMA Compact Dynamic Balancing Valve

Function

The SIGMA Compact reacts to pressure fluctuations in a system in order to keep the differential pressure across the pre-set unit constant. By achieving this, a maximum flow limit is ensured in accordance with the design.

The following applies to all flow control valves:

$$Q = kV * \sqrt{\Delta p}$$

Q = Flow (m³/h)

kV = Opening area

Δp = Differential pressure (Bar)

Simplified Outline

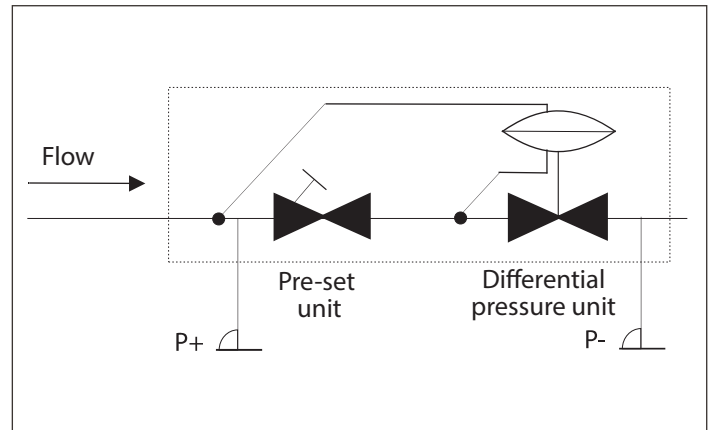

Flow Characteristic

The illustration shows how the flow in a SIGMA Compact valve reacts in accordance to the pump pressure. For comparison we have added a typical flow characteristic for a static balancing valve.

The differential pressure function of the valve will work when the differential pressure provided by the pump is sufficient to meet the required minimum differential pressure (which is dependent upon the required flow rate).

Once the minimum differential pressure is satisfied, the set flow rate is maintained regardless of any pressure fluctuations in the system.

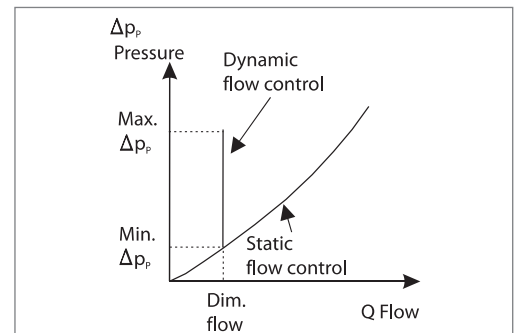

Setting the Valve

The SIGMA Compact is easily set using the pre-setting scale located on the hand wheel. The set point of the valve can be determined by using the flow graphs or tables on the last pages or the Frese APP for the valve dimension in question.

The scale on the hand wheel is for the adjustment of flow.

Pre-setting max flow position.

- Set the valve handle to the desired flow
- Remove cap marked Frese, and tighten (turn clockwise) with 2mm hexagonal key
- The valve can then be reopened to the pre-set flow after the valve has been used for isolation

To set the valve to another flow position, loosen the valve pre-setting with the 2mm hexagonal key (turn anti clockwise) and set the valve handle to the new flow position and tighten.

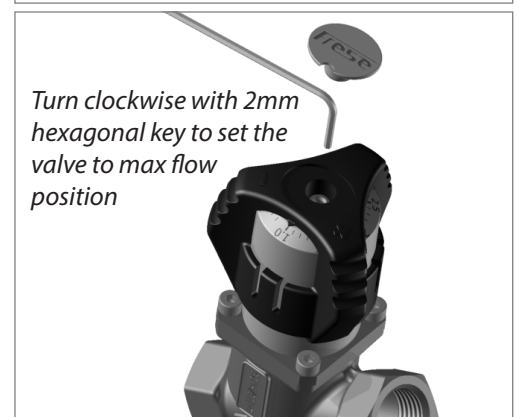

Isolation

To use the valve for isolation, turn the handle clockwise to the fully closed position. The valve will be closed ensuring leakage tightness according to EN1349 Class IV.

SIGMA Compact Dynamic Balancing Valve

Verification of Dynamic Systems

In general the flow rate in a system can be verified in two ways:

- Direct flow rate verification in a circuit
- Measurement of the differential pressure across the balancing valve or metering station

Direct flow rate verification

This can for example, be carried out by ultrasonic equipment. On the basis of the measured velocity of the flow and the pipe dimension the software will compute a flow rate. The use of ultrasonic verification requires free access to the pipes as the sensors are fitted directly to the pipe.

Measurement of the differential pressure

This is the main method of flow verification.

Once the design flow rate is known, the valve can be set using the flow graphs or Frese APP. Either of these tools will show the required set point and the required minimum differential pressure for the set flow rate.

Once the differential pressure has been verified, the flow rate can be recorded according to the flow rate graphs provided.

If the measured differential pressure is below the minimum Δp required for that set point, the flow can be found by using the formulas below.

Flow Calculation

$Q = kV \cdot \sqrt{\Delta p}$	$Q = m^3/h$ $\Delta p = \text{Bar}$
$Q = kV \cdot 100 \cdot \sqrt{\Delta p}$	$Q = l/h$ $\Delta p = \text{kPa}$
$Q = \frac{kV}{36} \cdot \sqrt{\Delta p}$	$Q = l/s$ $\Delta p = \text{kPa}$

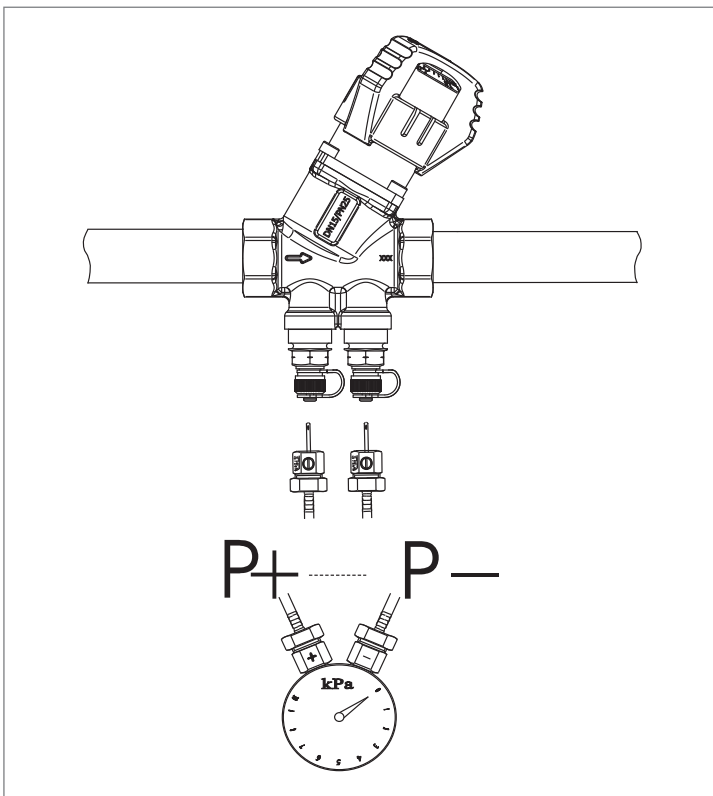

Measurement of the differential pressure (Δp) across the valve

SIGMA Compact Dynamic Balancing Valve

Application Diagrams

Frese SIGMA Compact installed in a circuit with heating or cooling coils

The system is easily balanced by adjusting the pump according to the required differential pressure across the valve located at the furthest point from the pump, known as the critical valve (P+ - P-).

When the minimum required differential pressure is available at the critical valve, sufficient differential pressure will be available in the rest of the system and the system will be automatically balanced.

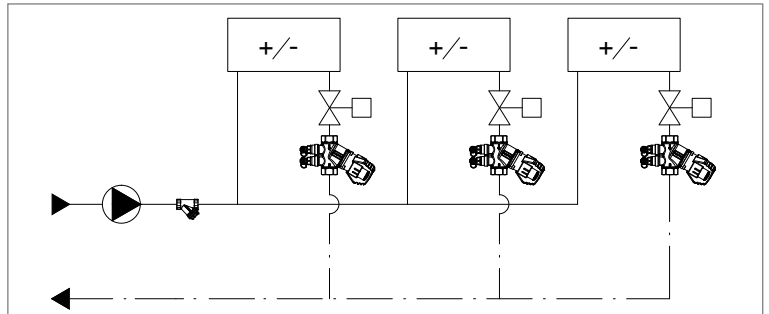

Frese SIGMA Compact in installations with injection circuits

Please note:
The balance is controlled by the Frese SIGMA Compact valves fitted in each control zone.

Major branch balancing valves are eliminated, even if the system may be larger and with far more branches than shown in this diagram.

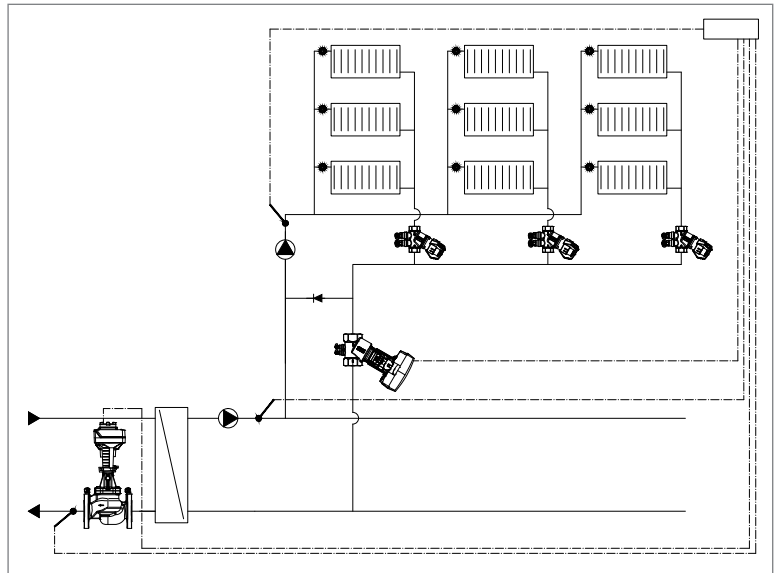

Flow rate example Frese SIGMA Compact DN15 High

Required design flow rate 600 l/h - 0,167 l/s

1. The required design flow rate is used as the point of reference for the overall rating of dynamic systems. (See the graph)
2. The pre-setting for the valve can be determined using the flow rate graph or the Frese APP. Setting = 2.2
3. On the right axis, the minimum differential pressure required from the pump can be determined. Minimum DP required approx. 14.5 kPa.

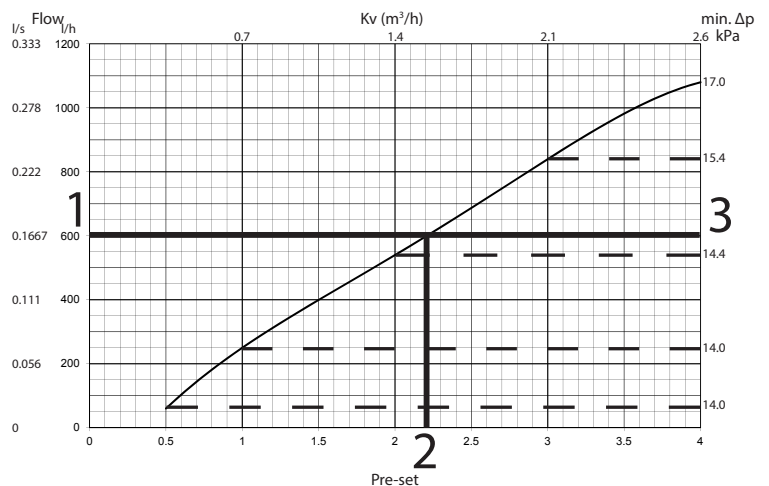

SIGMA Compact Dynamic Balancing Valve

Technical Data

Housing DN15-32:	DZR Brass CW602N
DN40-50:	Ductile Iron GJS-400
Flow setting:	PA6 (20% glass)
Spring:	Stainless steel
Diaphragm:	HNBR
O-rings:	EPDM
Pressure class:	PN25
Max. differential pressure:	400 kPa
Needles for DP measurement:	Max diameter, $\varnothing 3.2$ mm Length, 25 - 40 mm
Temperature range:	-10°C to + 120°C

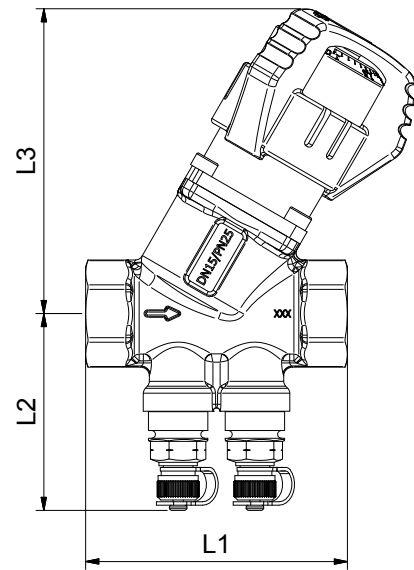

The pipe system shall be properly ventilated to avoid risk of air pockets. Glycolic mixtures up to 50% are applicable (both ethylene and propylene).
Recommendation: Water treatment to VDI 2035.

Frese SIGMA Compact

Dimension		DN15	DN20	DN25	DN32	DN40	DN50	
Flow rate	l/s	Low	0.011 - 0.250	0.024 - 0.431	0.026 - 0.556	0.056 - 1.389	0.200 - 2.056	0.250 - 2.875
		High	0.017 - 0.300	0.028 - 0.536	0.038 - 0.667			
	l/h	Low	40 - 900	86 - 1550	95 - 2000	200 - 5000	719 - 7400	900 - 10350
		High	60 - 1080	102 - 1930	137 - 2400			
gpm	Low	0.18 - 3.96	0.38 - 6.82	0.42 - 8.81	0.88 - 22.01	3.17 - 32.58	3.96 - 45.57	
	High	0.26 - 4.75	0.45 - 8.50	0.60 - 10.57				
Kvs (Low/High)	m ³ /h	2.6/2.6	4.0/4.0	3.9/4.2	10.9	18.0	20.3	
Dimension mm	L1	75	79	83	104	138	138	
	L2	57	57	59	68	70	76	
	L2 *	66	66	68	77	79	85	
	L3	87	87	90	110	131	131	
Weight	kg	0.5	0.6	0.7	1.4	3.0	3.4	

(*) Valves with drain

SIGMA Compact Dynamic Balancing Valve

Product Programme

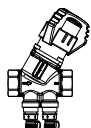
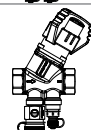
SIGMA Compact		DN15	DN20	DN25	DN32	DN40	DN50
	P/T plugs	Low 53-2200 High 53-2201	Low 53-2202 High 53-2203	Low 53-2208 High 53-2209	53-2205	53-2206	53-2207
	P/T plug + drain valve	Low 53-2220 High 53-2221	Low 53-2222 High 53-2223	Low 53-2228 High 53-2229	53-2225	53-2226	53-2227

Accessories

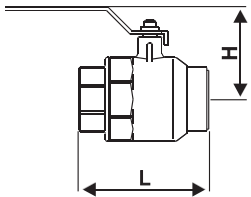
Ball Valve for Servicing, Female/Male	Dim.	Weight [kg]	L [mm]	H [mm]	Frese no.	
	Valve Housing: DZR brass, CW602N	DN15	0.195	62	44	38-5020
	O-rings: EPDM	DN20	0.327	73	47	38-5022
	Seal: PTFE	DN25	0.502	85	55	38-5024
	Pressure class: PN20	DN32	0.869	106	75	38-5026
	Temperature: -20°C to 110°C	DN40	1.348	113	82	38-5028
	Thread: ISO 228	DN50	2.371	135	94	38-5030

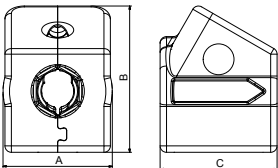
Insulation Cover - for heating applications only	Valve Dim.	Insulation Cover AxBxC [mm]	Frese no.	
	Material: EPP (Expanded Polypropylene)	DN15-DN20	85 x 114 x 91	38-0861
	Water absorption: < 2.5 vol% at 20°C	DN25	119 x 134 x 102	38-0862
	Temperature range: Up to 120°C	DN25L-DN32	131 x 165 x 115	38-0863
Insulating property: Lambda = 0.039 W/mk				
Density: 50 g/l				
Fire resistant: According to DIN 4102: B2				

Text for Technical Specifications

- The valve should be a dynamic balancing valve with the option of setting the flow without interference of operation.
- The valve should include P/T plugs for the verification of differential pressure.
- The valve should only be adjustable by means of a hand wheel to limit the maximum flow.
- The flow setting control unit shall be pressure independent.
- The dynamic balancing valve shall contain a combined flow setting and differential pressure control bonnet assembly.
- The valve housing shall be DZR brass for DN15-32 and ductile iron for DN40-50.
- The valve shall have a spring made of stainless steel, a diaphragm made of HNBR and O-rings made of EPDM.
- The valve housing shall be PN25 rated and suitable for 120°C.
- The valve shall have a thread according to ISO 228.
- The valve shall have a maximum operating differential pressure of 400 kPa (4 Bar)
- The valve shall have an external adjustable analogue stepless pre-setting scale from minimum to maximum flow.
- The valve in isolated position shall have a leakage rate at maximum 0.01% of maximum rated volumetric flow and comply to EN1349 Class IV.

SIGMA Compact Dynamic Balancing Valve

Frese SIGMA Compact DN15 Low

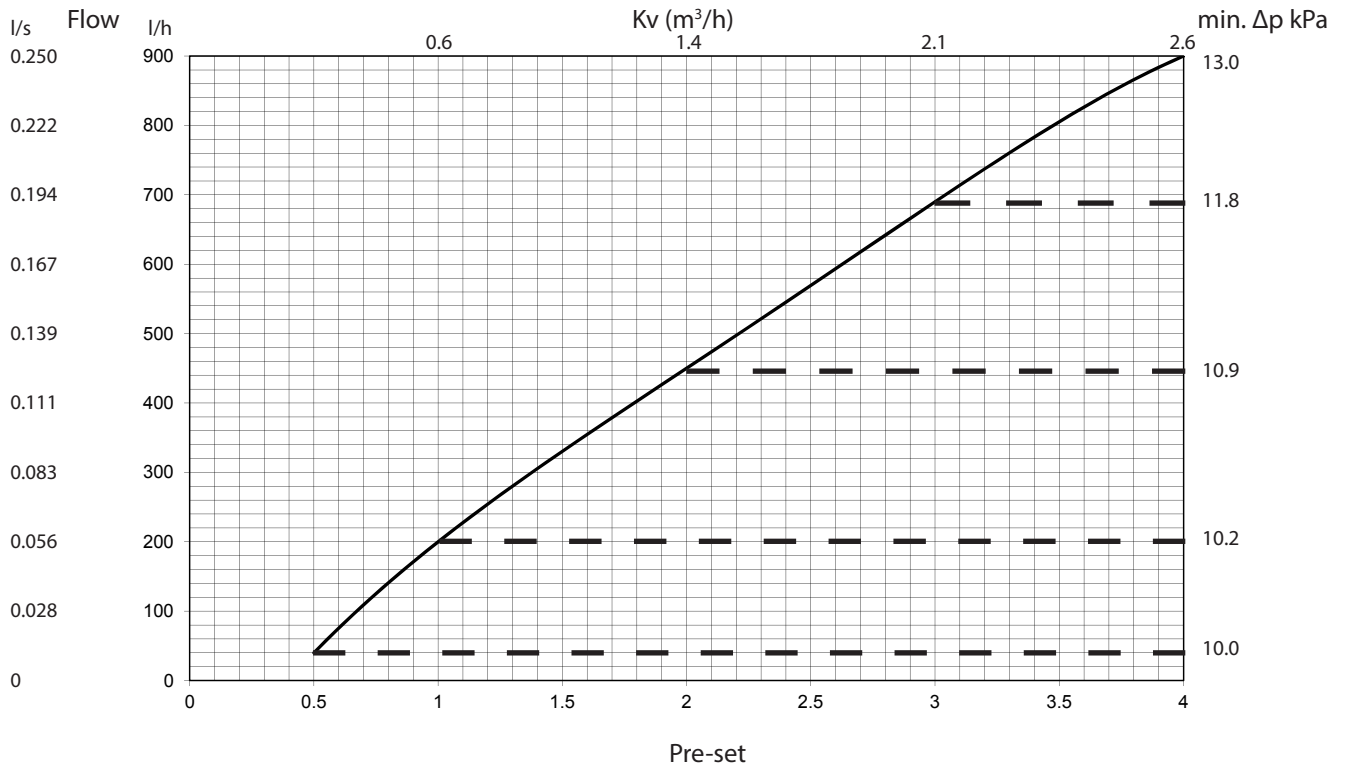

Frese SIGMA Compact DN15 High

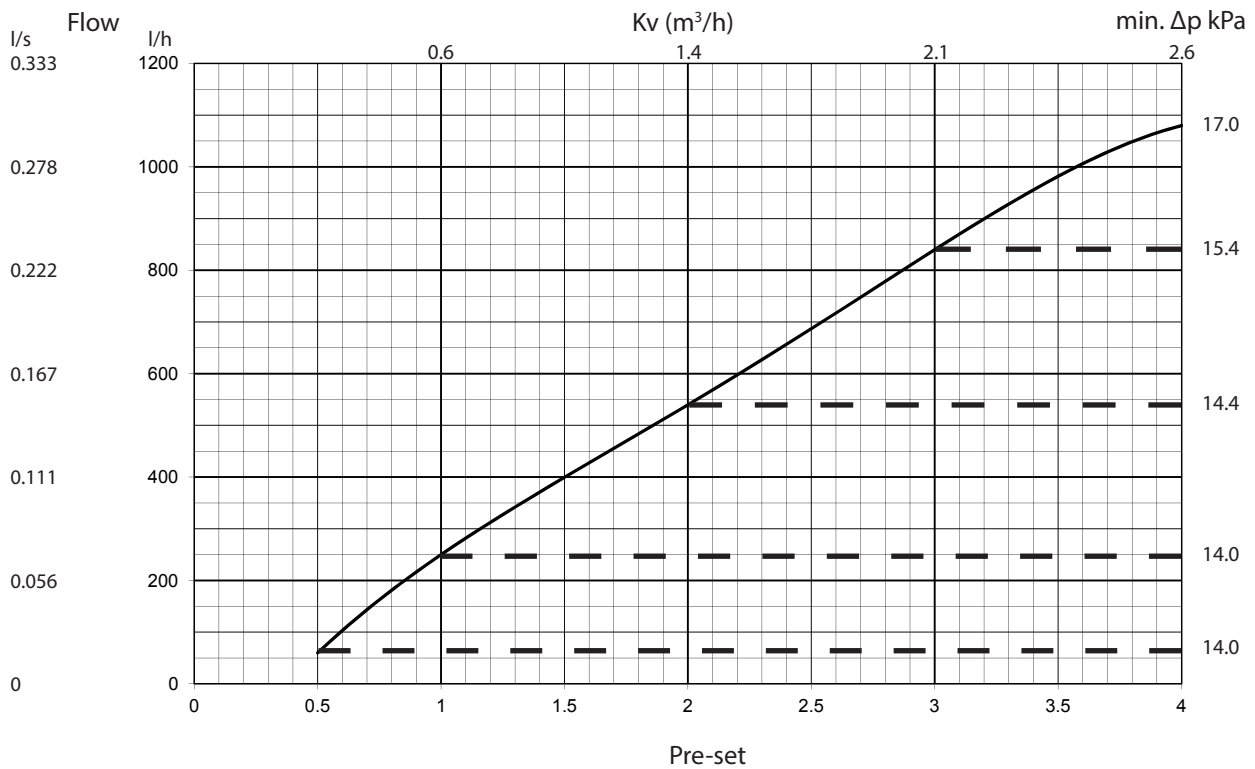

SIGMA Compact Dynamic Balancing Valve

Frese SIGMA Compact DN20 Low

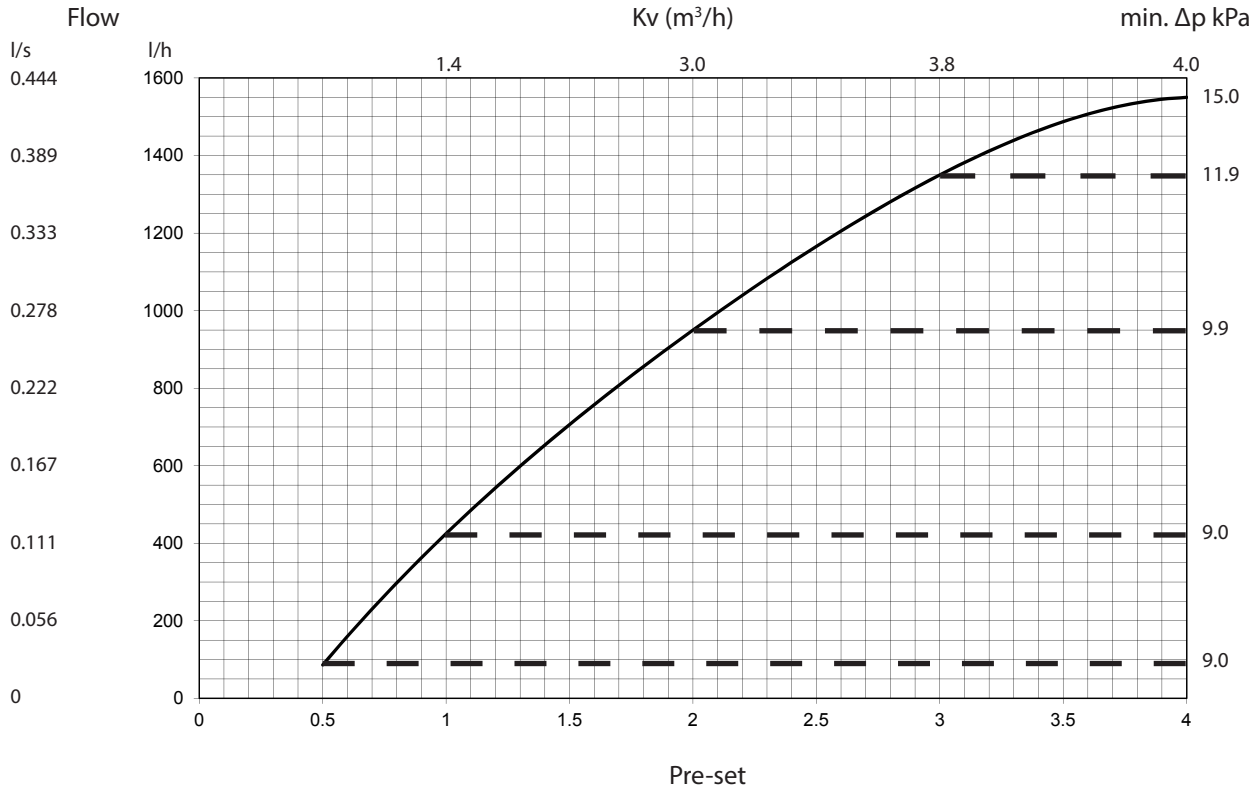

Frese SIGMA Compact DN20 High

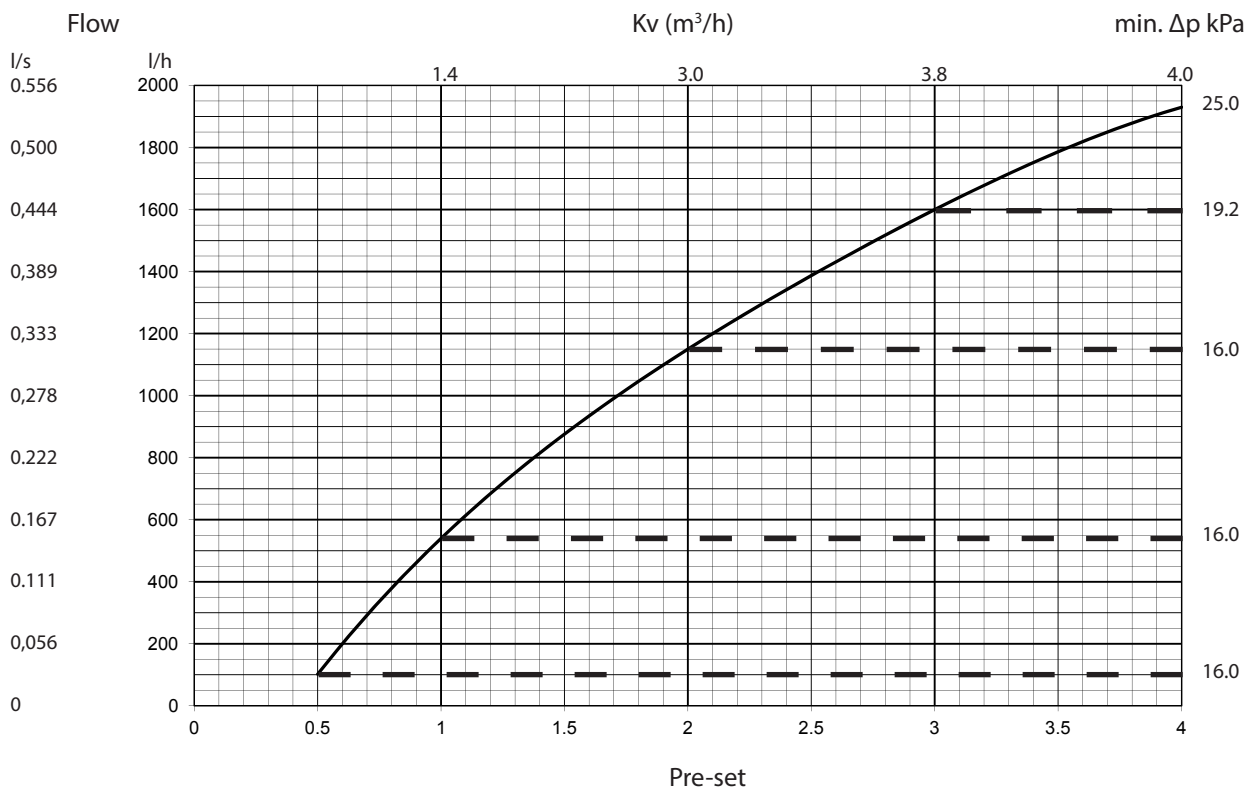

SIGMA Compact Dynamic Balancing Valve

Frese SIGMA Compact DN25 Low

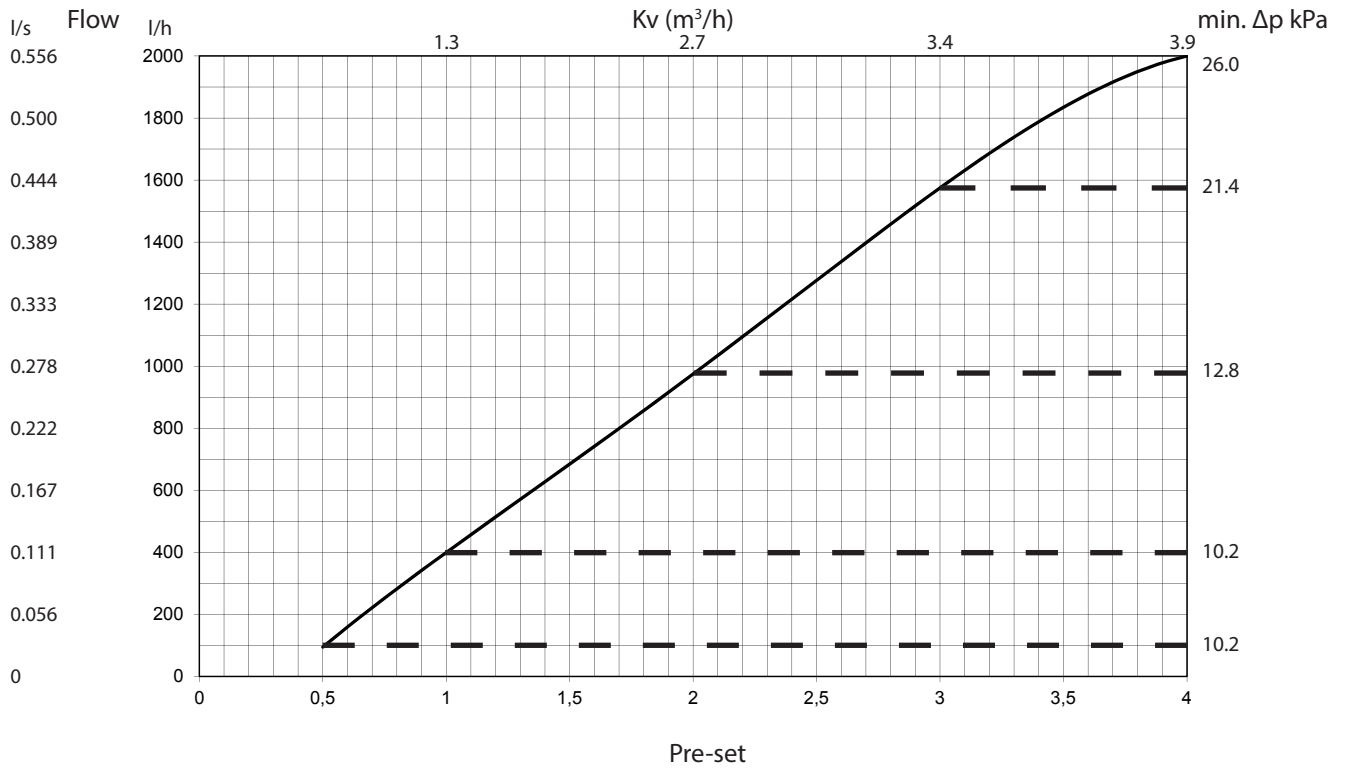

Frese SIGMA Compact DN25 High

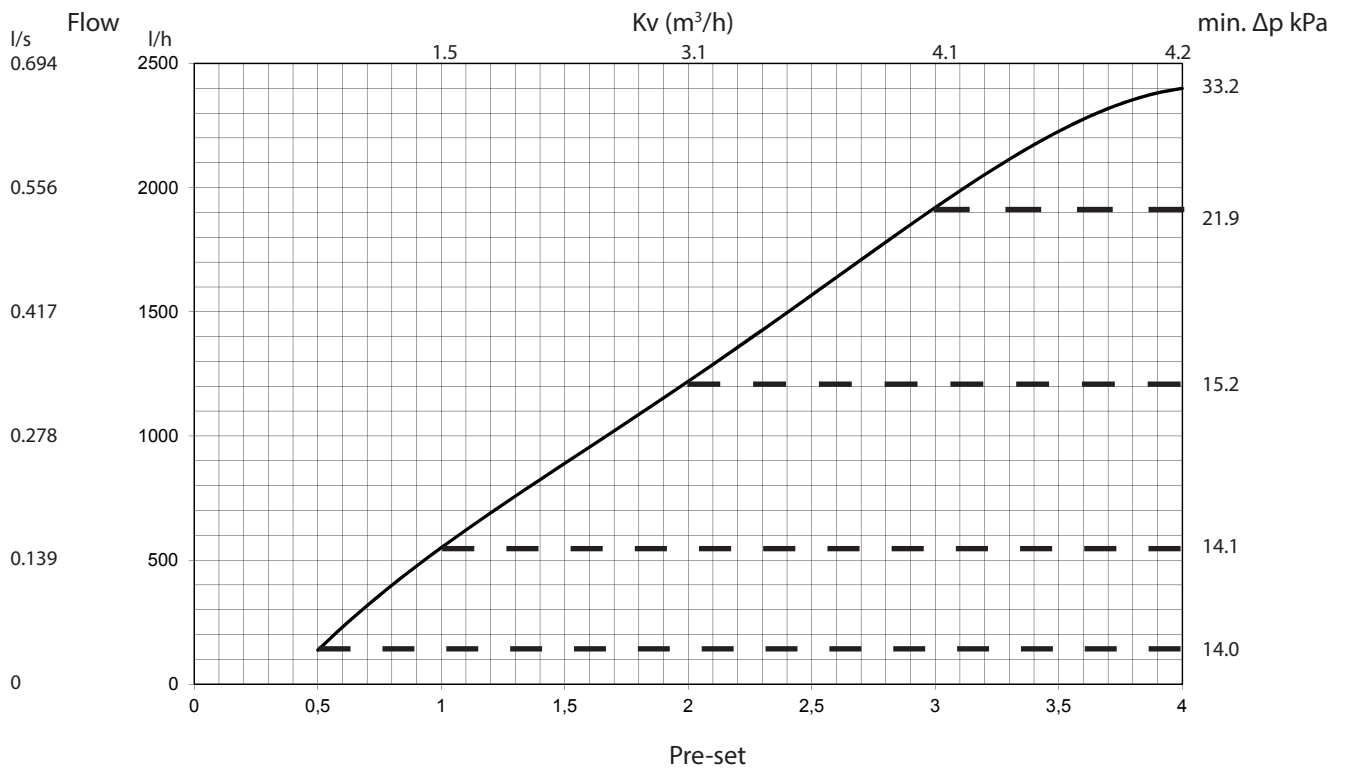

SIGMA Compact Dynamic Balancing Valve

Frese SIGMA Compact DN32

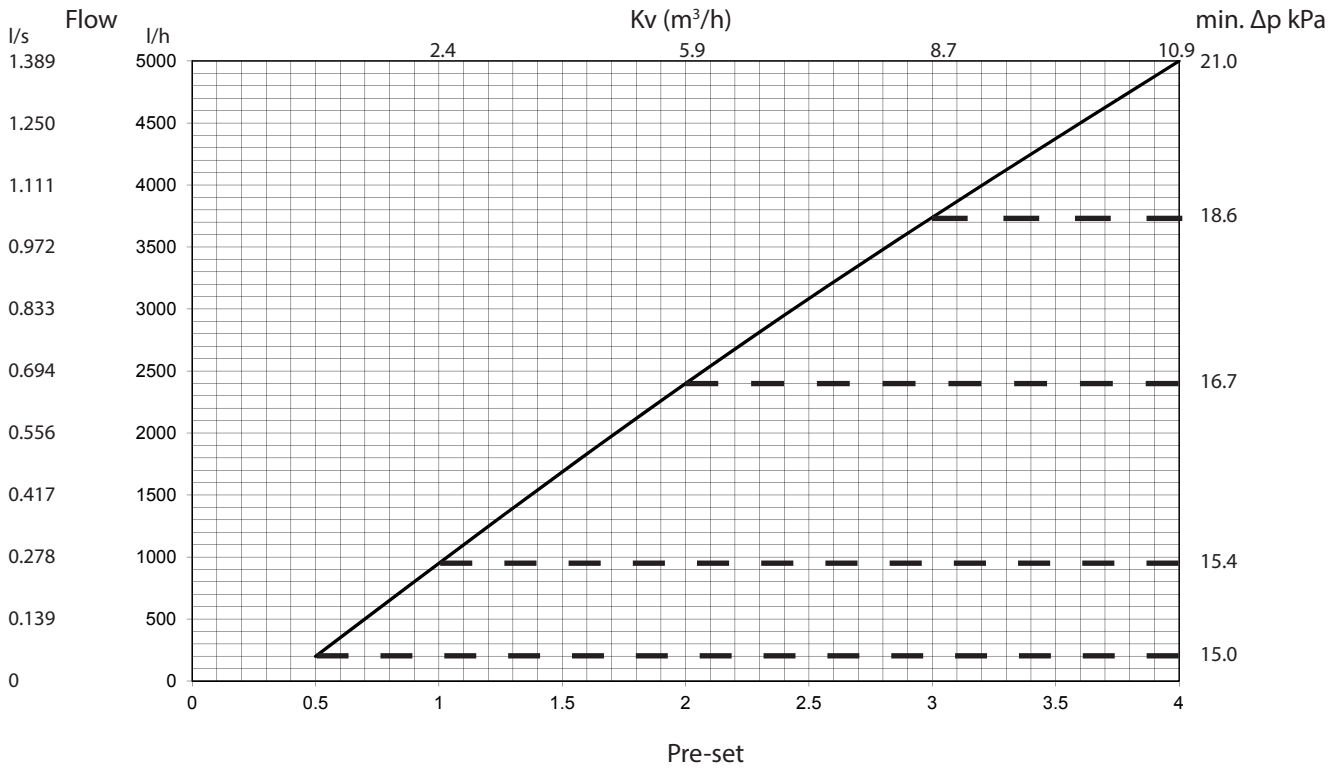

Frese SIGMA Compact DN40

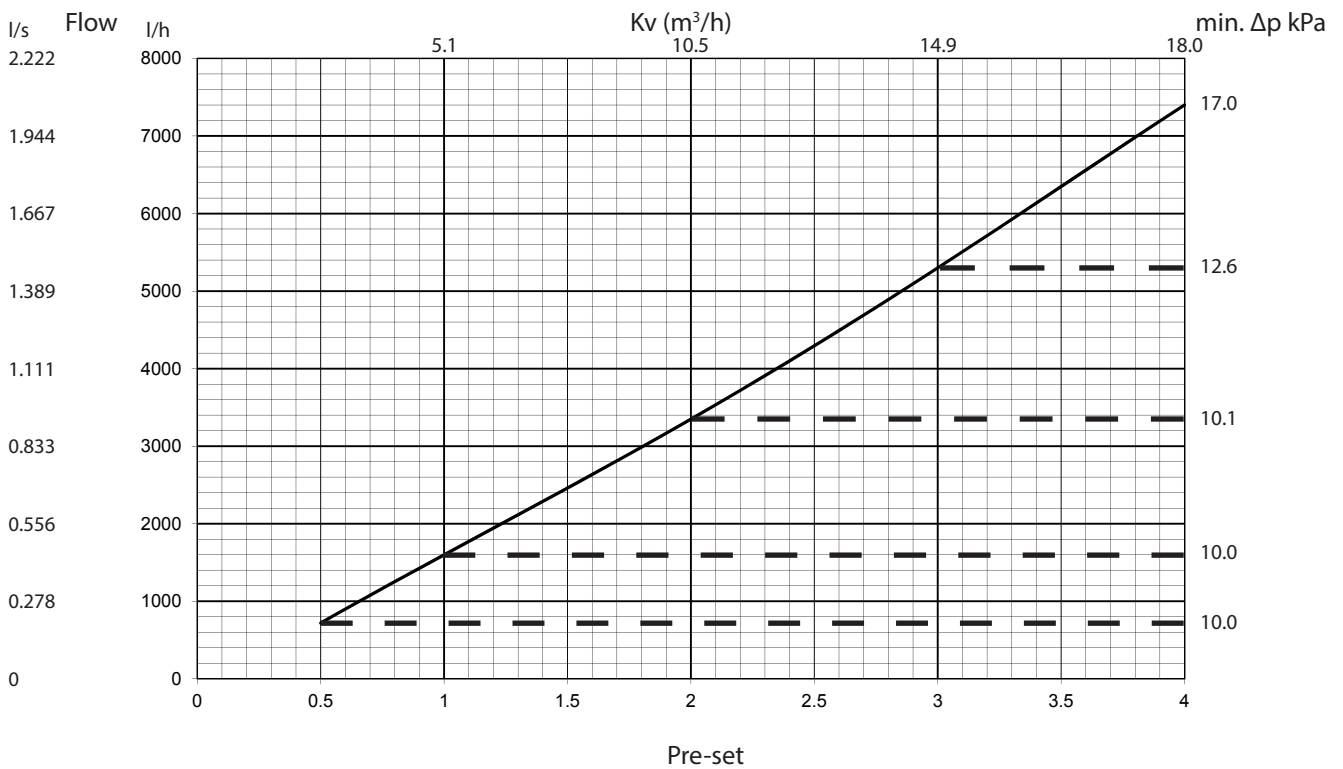

SIGMA Compact Dynamic Balancing Valve

Frese SIGMA Compact DN50

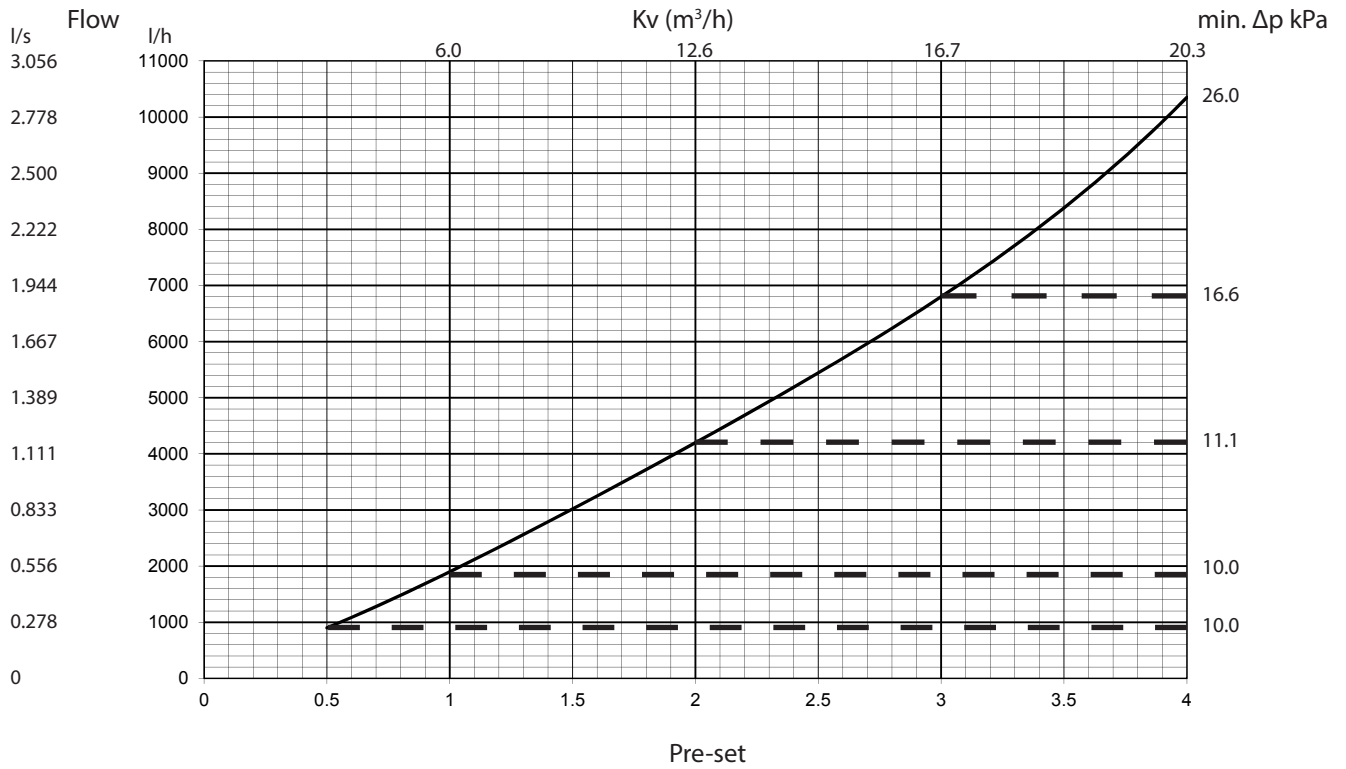

SIGMA Compact Dynamic Balancing Valve

Setting and Flow

Pre-set	Frese SIGMA Compact DN15 Low			Frese SIGMA Compact DN15 High			Frese SIGMA Compact DN20 Low		
	Flow l/h	Flow l/s	Flow gpm	Flow l/h	Flow l/s	Flow gpm	Flow l/h	Flow l/s	Flow gpm
0.5	40	0.011	0.18	60	0.017	0.26	86	0.024	0.38
0.6	76	0.021	0.33	103	0.029	0.45	160	0.044	0.70
0.7	109	0.030	0.48	144	0.040	0.63	230	0.064	1.01
0.8	141	0.039	0.62	181	0.050	0.80	298	0.083	1.31
0.9	171	0.048	0.75	217	0.060	0.95	363	0.101	1.60
1.0	200	0.056	0.88	250	0.069	1.10	425	0.118	1.87
1.1	228	0.063	1.00	282	0.078	1.24	485	0.135	2.14
1.2	254	0.071	1.12	313	0.087	1.38	543	0.151	2.39
1.3	280	0.078	1.23	342	0.095	1.51	599	0.166	2.64
1.4	306	0.085	1.35	371	0.103	1.63	653	0.181	2.88
1.5	330	0.092	1.45	399	0.111	1.76	706	0.196	3.11
1.6	355	0.099	1.56	428	0.119	1.88	757	0.210	3.33
1.7	379	0.105	1.67	456	0.127	2.01	807	0.224	3.55
1.8	403	0.112	1.77	483	0.134	2.13	856	0.238	3.77
1.9	426	0.118	1.88	512	0.142	2.25	904	0.251	3.98
2.0	450	0.125	1.98	540	0.150	2.38	950	0.264	4.18
2.1	474	0.132	2.09	569	0.158	2.50	995	0.276	4.38
2.2	497	0.138	2.19	598	0.166	2.63	1040	0.289	4.58
2.3	521	0.145	2.30	627	0.174	2.76	1083	0.301	4.77
2.4	545	0.151	2.40	657	0.182	2.89	1125	0.312	4.95
2.5	569	0.158	2.51	687	0.191	3.02	1166	0.324	5.13
2.6	593	0.165	2.61	717	0.199	3.16	1205	0.335	5.31
2.7	618	0.172	2.72	748	0.208	3.29	1244	0.346	5.48
2.8	642	0.178	2.83	779	0.216	3.43	1281	0.356	5.64
2.9	666	0.185	2.93	809	0.225	3.56	1316	0.366	5.80
3.0	690	0.192	3.04	840	0.233	3.70	1350	0.375	5.94
3.1	714	0.198	3.14	870	0.242	3.83	1382	0.384	6.08
3.2	737	0.205	3.25	900	0.250	3.96	1412	0.392	6.22
3.3	761	0.211	3.35	928	0.258	4.09	1439	0.400	6.34
3.4	783	0.218	3.45	956	0.265	4.21	1465	0.407	6.45
3.5	805	0.224	3.55	982	0.273	4.32	1487	0.413	6.55
3.6	827	0.230	3.64	1006	0.280	4.43	1507	0.419	6.63
3.7	847	0.235	3.73	1029	0.286	4.53	1523	0.423	6.71
3.8	866	0.241	3.81	1049	0.291	4.62	1536	0.427	6.76
3.9	884	0.245	3.89	1066	0.296	4.69	1545	0.429	6.80
4.0	900	0.250	3.96	1080	0.300	4.75	1550	0.431	6.82

SIGMA Compact Dynamic Balancing Valve

Setting and Flow

Pre-set	Frese SIGMA Compact DN20 High			Frese SIGMA Compact DN25 Low			Frese SIGMA Compact DN25 High		
	Flow l/h	Flow l/s	Flow gpm	Flow l/h	Flow l/s	Flow gpm	Flow l/h	Flow l/s	Flow gpm
0.5	102	0.028	0.45	95	0.026	0.42	137	0.038	0.60
0.6	200	0.056	0.88	160	0.044	0.70	230	0.064	1.01
0.7	292	0.081	1.29	222	0.062	0.98	317	0.088	1.39
0.8	380	0.105	1.67	283	0.078	1.24	399	0.111	1.75
0.9	462	0.128	2.03	342	0.095	1.50	476	0.132	2.10
1.0	540	0.150	2.38	400	0.111	1.76	550	0.153	2.42
1.1	614	0.171	2.70	457	0.127	2.01	621	0.173	2.73
1.2	684	0.190	3.01	514	0.143	2.26	690	0.192	3.04
1.3	751	0.209	3.31	571	0.159	2.51	758	0.210	3.34
1.4	815	0.226	3.59	628	0.174	2.76	824	0.229	3.63
1.5	876	0.243	3.86	685	0.190	3.01	890	0.247	3.92
1.6	935	0.260	4.12	742	0.206	3.27	955	0.265	4.20
1.7	991	0.275	4.36	799	0.222	3.52	1020	0.283	4.49
1.8	1046	0.291	4.61	857	0.238	3.77	1086	0.302	4.78
1.9	1099	0.305	4.84	916	0.254	4.03	1153	0.320	5.08
2.0	1150	0.319	5.06	975	0.271	4.29	1220	0.339	5.37
2.1	1200	0.333	5.28	1035	0.287	4.56	1288	0.358	5.67
2.2	1248	0.347	5.50	1095	0.304	4.82	1357	0.377	5.97
2.3	1296	0.360	5.70	1155	0.321	5.09	1426	0.396	6.28
2.4	1342	0.373	5.91	1216	0.338	5.35	1497	0.416	6.59
2.5	1387	0.385	6.11	1277	0.355	5.62	1568	0.435	6.90
2.6	1432	0.398	6.30	1337	0.372	5.89	1639	0.455	7.21
2.7	1475	0.410	6.49	1398	0.388	6.15	1710	0.475	7.53
2.8	1518	0.422	6.68	1458	0.405	6.42	1781	0.495	7.84
2.9	1559	0.433	6.87	1517	0.421	6.68	1851	0.514	8.15
3.0	1600	0.444	7.04	1575	0.438	6.93	1920	0.533	8.45
3.1	1640	0.455	7.22	1632	0.453	7.18	1987	0.552	8.75
3.2	1678	0.466	7.39	1686	0.468	7.42	2052	0.570	9.04
3.3	1716	0.477	7.55	1739	0.483	7.65	2114	0.587	9.31
3.4	1752	0.487	7.71	1788	0.497	7.87	2173	0.604	9.57
3.5	1786	0.496	7.86	1835	0.510	8.08	2227	0.619	9.80
3.6	1819	0.505	8.01	1877	0.521	8.27	2276	0.632	10.02
3.7	1850	0.514	8.15	1916	0.532	8.44	2319	0.644	10.21
3.8	1879	0.522	8.27	1950	0.542	8.58	2354	0.654	10.36
3.9	1906	0.529	8.39	1978	0.549	8.71	2382	0.662	10.49
4.0	1930	0.536	8.50	2000	0.556	8.81	2400	0.667	10.57

SIGMA Compact Dynamic Balancing Valve

Setting and Flow

Pre-set	Frese SIGMA Compact DN32			Frese SIGMA Compact DN40			Frese SIGMA Compact DN50		
	Flow l/h	Flow l/s	Flow gpm	Flow l/h	Flow l/s	Flow gpm	Flow l/h	Flow l/s	Flow gpm
0.5	200	0.056	0.88	719	0.200	3.17	900	0.250	3.96
0.6	350	0.097	1.54	900	0.250	3.96	1086	0.302	4.78
0.7	500	0.139	2.20	1078	0.299	4.75	1280	0.356	5.63
0.8	651	0.181	2.86	1254	0.348	5.52	1481	0.411	6.52
0.9	801	0.222	3.52	1427	0.396	6.28	1688	0.469	7.43
1.0	950	0.264	4.18	1600	0.444	7.04	1900	0.528	8.37
1.1	1099	0.305	4.84	1772	0.492	7.80	2117	0.588	9.32
1.2	1247	0.346	5.49	1943	0.540	8.56	2338	0.649	10.29
1.3	1395	0.387	6.14	2115	0.588	9.31	2562	0.712	11.28
1.4	1541	0.428	6.79	2287	0.635	10.07	2789	0.775	12.28
1.5	1687	0.469	7.43	2461	0.684	10.83	3019	0.839	13.29
1.6	1832	0.509	8.06	2635	0.732	11.60	3251	0.903	14.31
1.7	1976	0.549	8.70	2811	0.781	12.38	3485	0.968	15.34
1.8	2118	0.588	9.33	2989	0.830	13.16	3721	1.034	16.38
1.9	2260	0.628	9.95	3168	0.880	13.95	3960	1.100	17.43
2.0	2400	0.667	10.57	3350	0.931	14.75	4200	1.167	18.49
2.1	2539	0.705	11.18	3534	0.982	15.56	4443	1.234	19.56
2.2	2677	0.744	11.79	3720	1.033	16.38	4688	1.302	20.64
2.3	2814	0.782	12.39	3909	1.086	17.21	4936	1.371	21.73
2.4	2950	0.819	12.99	4101	1.139	18.06	5187	1.441	22.84
2.5	3084	0.857	13.58	4295	1.193	18.91	5442	1.512	23.96
2.6	3217	0.894	14.17	4491	1.248	19.77	5702	1.584	25.10
2.7	3350	0.930	14.75	4690	1.303	20.65	5967	1.657	26.27
2.8	3481	0.967	15.32	4891	1.359	21.54	6237	1.733	27.46
2.9	3611	1.003	15.90	5095	1.415	22.43	6515	1.810	28.68
3.0	3740	1.039	16.47	5300	1.472	23.33	6800	1.889	29.94
3.1	3868	1.075	17.03	5507	1.530	24.25	7094	1.971	31.23
3.2	3996	1.110	17.59	5716	1.588	25.17	7398	2.055	32.57
3.3	4123	1.145	18.15	5926	1.646	26.09	7713	2.142	33.96
3.4	4249	1.180	18.71	6137	1.705	27.02	8040	2.233	35.40
3.5	4375	1.215	19.26	6348	1.763	27.95	8381	2.328	36.90
3.6	4500	1.250	19.81	6560	1.822	28.88	8738	2.427	38.47
3.7	4625	1.285	20.36	6771	1.881	29.81	9111	2.531	40.12
3.8	4750	1.319	20.91	6982	1.940	30.74	9503	2.640	41.84
3.9	4875	1.354	21.46	7192	1.998	31.66	9916	2.754	43.66
4.0	5000	1.389	22.01	7400	2.056	32.58	10350	2.875	45.57

Frese A/S assumes no responsibility for errors, if any, in catalogues, brochures, and other printed matter. Frese A/S reserves the right to modify its products without prior notice, including already ordered products, if this does not alter existing specifications. All registered trademarks in this material are the property of Frese A/S. All rights reserved.