

## Frese PV-SIGMA Compact Dynamic Pressure and Flow Regulation

### Description

The Frese PV-SIGMA Compact system is a dynamic valve arrangement designed to regulate flow and differential pressure.

### Application

The Frese PV-SIGMA Compact system can be installed in both domestic and commercial heating and cooling systems.

The PV-SIGMA Compact combines the Frese SIGMA Compact dynamic balancing valve positioned in the flow and the Frese PV Compact differential pressure control valve positioned in the return.

### Operation

The Frese PV-SIGMA Compact system ensures 100% flow and differential pressure regulation under all conditions, irrespective of any changes within the system whilst providing simple and trouble free commissioning.

The Frese PV-SIGMA Compact system operates by limiting the flow and pressure in a system, eliminating any noise caused by excess differential pressure.

### Benefits

- Simple presetting of flow and differential pressure.
- Positive close off to prevent rising differential pressure when control valves in the controlled circuit are fully closed.
- Flow and differential pressure can be adjusted independently of each other.
- Differential pressure can be easily adjusted after installation.
- Tamperproof presetting device fitted on the top of the differential pressure control valve.
- No additional commissioning required if the system design is changed.
- High levels of comfort and energy savings for the end user.
- The PV Compact eliminates noise caused by high differential pressure whilst the SIGMA Compact limits the flow in a system, ensuring no overflows.

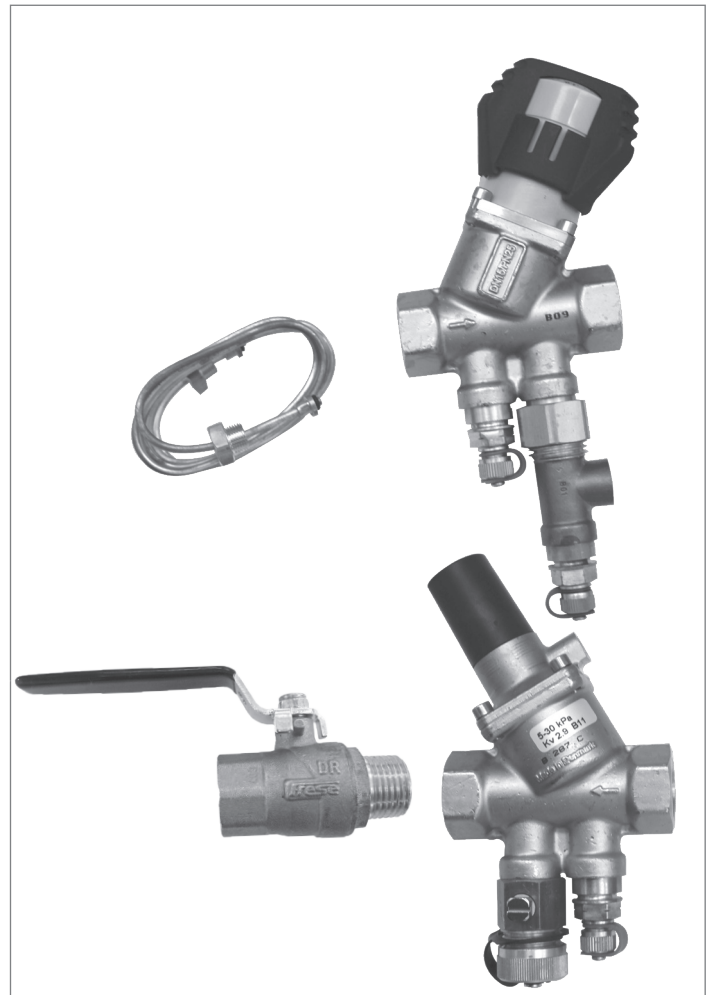

### Features

- Size range: DN15 to DN50
- Maximum flow: 10.3m<sup>3</sup>/h
- Maximum differential pressure 400kPa
- Setting ranges: 5-30kPa, 20-60kPa and 20-80kPa
- Differential pressure regulation, flow regulation, drain and PT plugs as standard
- Isolation function in the flow direction on the SIGMA Compact
- Compact housings for easy installation

# Frese PV-SIGMA Compact Dynamic Pressure and Flow Regulation

## Design Frese PV-SIGMA Compact

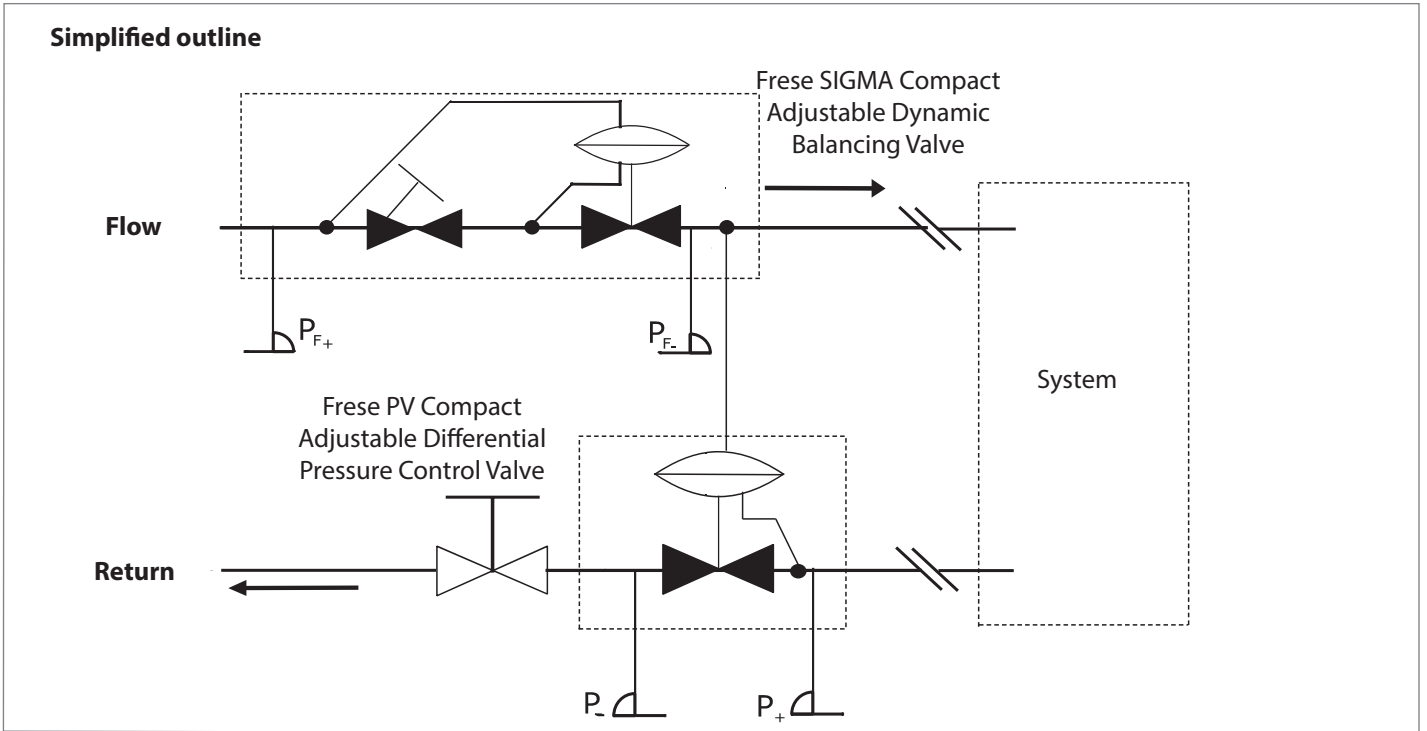

### Measurement of differential pressure and flow across the valve

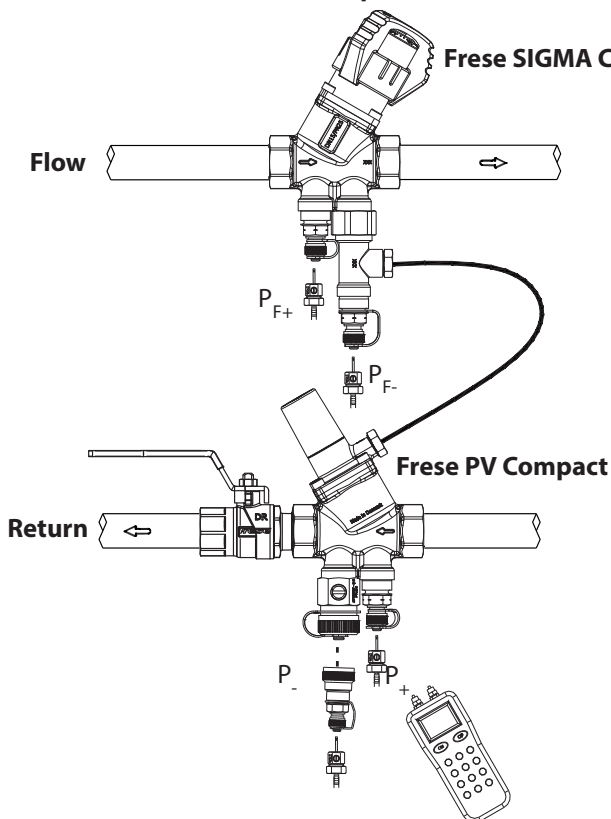

Design flow: The flow is adjusted directly on Frese SIGMA Compact (see graphs on the pre-set diagram)

Differential pressure :  $\Delta P_S$  is adjusted directly on Frese PV Compact (see graphs on the pre-set diagram)

The flow in the system is verified by measuring minimum differential pressure (min.  $\Delta p$ ) is available across the Frese SIGMA Compact valve. Measured from  $P_{F+}$  to  $P_{F-}$  (see graphs on the pre-set diagram)

The differential pressure of the system ( $\Delta P_S$ ) is measured from  $P_{F-}$  to  $P_{+}$

# Frese PV-SIGMA Compact Dynamic Pressure and Flow Regulation

## Technical data

|                                    |                                      |
|------------------------------------|--------------------------------------|
| <b>Housing DN15-32:</b>            | DZR Brass, CW602N                    |
| <b>DN40-50</b>                     | Ductile Iron                         |
| <b>DP controller:</b>              | PPS (40% glass)                      |
| <b>Flow setting:</b>               | PA6 (20% glass)                      |
| <b>Spring:</b>                     | Stainless steel                      |
| <b>Diaphragm:</b>                  | HNBR                                 |
| <b>O-rings:</b>                    | EPDM                                 |
| <b>Pressure class:</b>             | PN25 (PV+SIGMA)<br>PN16 (Ball valve) |
| <b>Max. differential pressure:</b> | 400 kPa                              |
| <b>Temperature range:</b>          | -10°C to + 120°C                     |
| <b>Capillary tube:</b>             | Ø3, L = 1000 mm                      |

The pipe system shall be properly ventilated to avoid risk of air pockets. Glycolic mixtures up to 50% are applicable (both ethylene and propylene).  
Recommendation: Water treatment to VDI 2035.

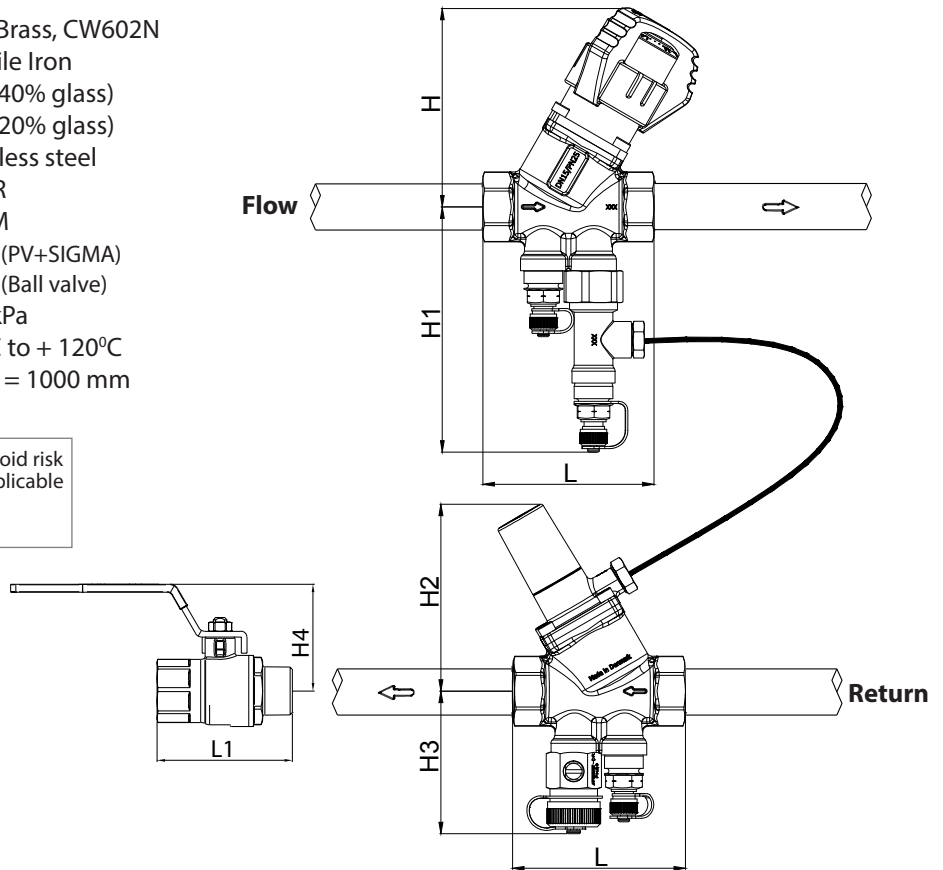

## Frese PV-SIGMA Compact



| Dimension     |     | DN15          |               | DN20          |               | DN25          |               | DN32          | DN40          | DN50          |
|---------------|-----|---------------|---------------|---------------|---------------|---------------|---------------|---------------|---------------|---------------|
| Version       |     | Low           | High          | Low           | High          | Low           | High          | -             | -             | -             |
| Control range | kPa | 5-30          | 20-60         | 5-30          | 20-60         | 5-30          | 20-80         | 20-80         | 20-80         | 20-80         |
| Flow range    | l/s | 0.014 - 0.167 | 0.028 - 0.278 | 0.028 - 0.278 | 0.042 - 0.536 | 0.167 - 0.583 | 0.208 - 0.667 | 0.278 - 1.389 | 0.833 - 2.056 | 1.389 - 2.875 |
|               | l/h | 50 - 600      | 100 - 1000    | 100 - 1000    | 150 - 1930    | 600 - 2100    | 750 - 2400    | 1000 - 5000   | 3000 - 7400   | 5000 - 10350  |
|               | gpm | 0.22 - 2.64   | 0.44 - 4.40   | 0.44 - 4.40   | 0.66 - 8.50   | 2.64 - 9.25   | 3.30 - 10.56  | 4.40 - 22.01  | 13.21 - 32.58 | 22.01 - 45.57 |
| Dimension mm  | L   | 75            |               | 79            |               | 78            | 78/100        | 104           | 138           | 138           |
|               | L1  | 60            |               | 66            |               | 78            |               | 96            | 103           | 125           |
|               | H   | 87            |               | 87            |               | 90            | 90            | 110           | 131           | 131           |
|               | H1  | 108           |               | 108           |               | 108           | 108           | 119           | 121           | 127           |
|               | H2  | 82            |               | 82            |               | 82            | 134           | 134           | 156           | 156           |
|               | H3  | 66            |               | 66            |               | 66            | 72            | 77            | 80            | 86            |
|               | H4  | 44            |               | 47            |               | 55            |               | 75            | 82            | 94            |

## Frese PV-SIGMA Compact Dynamic Pressure and Flow Regulation

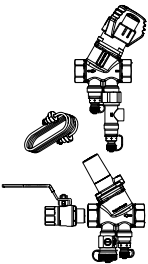
### Product programme

|  | Dimension   | DN15              | DN20              | DN25              | DN32                 | DN40             | DN50             |
|--|---|-------------------|-------------------|-------------------|----------------------|------------------|------------------|
| Frese PV-SIGMA Compact with drain valve, P/T plugs, isolation ball valve and capillary tube. |  | 53-3260           | 53-3262           | 53-3264           | 53-3266<br>20-80 kPa | 53-3267          | 53-3268          |
|  |   | Low<br>5-30 kPa   | Low<br>5-30 kPa   | Low<br>5-30 kPa   |                      | Low<br>20-80 kPa | Low<br>20-80 kPa |
|  |   | 53-3261           | 53-3263           | 53-3265           |                      |                  |                  |
|  |   | High<br>20-60 kPa | High<br>20-60 kPa | High<br>20-80 kPa |                      |                  |                  |

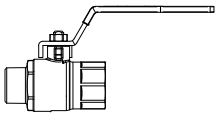
### Accessories

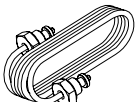
|  | Female/Male   | Dimensions | Frese no. |
|--|---|------------|-----------|
| Isolation ball valve                   |  | DN15       | 38-5020   |
|  |   | DN20       | 38-5022   |
|  |   | DN25       | 38-5024   |
|  |   | DN32       | 38-5026   |
|  |   | DN40       | 38-5028   |
|  |   | DN50       | 38-5030   |
| 1/2" Female end with P/T-plug          |  | -          | 48-0017   |
| Frese capillary tube<br>ø3mm x 1000 mm |  | -          | 48-0004   |

# Frese PV-SIGMA Compact Dynamic Pressure and Flow Regulation

## Example: Pre setting the valves

**Frese PV-SIGMA Compact DN15 Low  
Differential pressure system  
( $\Delta P_s$ ) 12 kPa**

**Design flow 500 l/h (0,139 l/s)**

### Differential pressure setting Frese PV Compact

1. The design flow is used as the point of reference for the setting. (See the graph)
2. In order to make reading easier the graphs indicating the pressure in the circuit are arranged at intervals of 5 kPa. Still, the graphs can be offset according to the specified pressure of 12 kPa in our circuit. From the intersection of the 12 kPa graph and the horizontal line indicating 500 l/h a line perpendicular to the x-axis is made to read the pre-set value.  
Pre-set app. 6 turns on the scale.

3. The minimum pressure drop required will be 3.0 kPa across the valve. ( $\Delta P_{V2}$ )

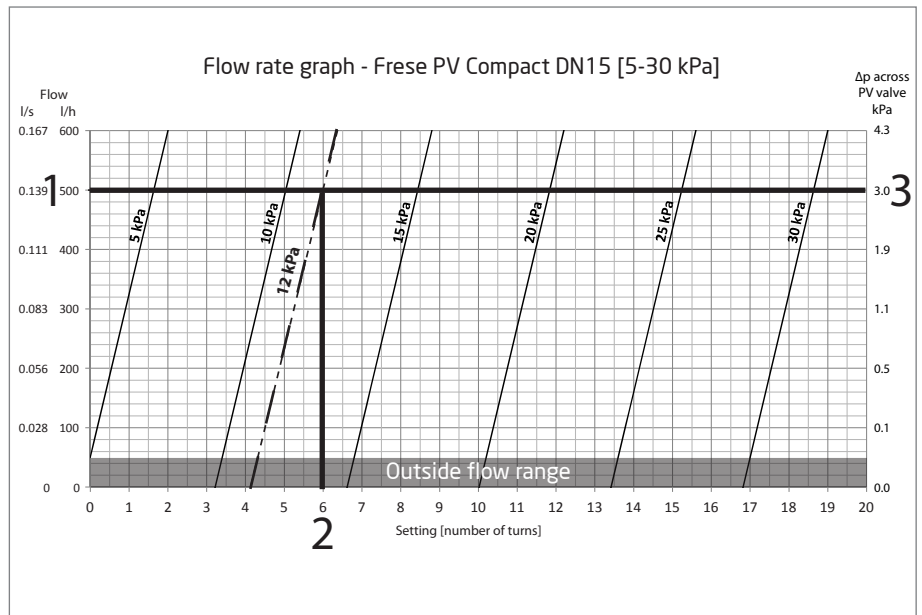

### Flow setting Frese SIGMA Compact DN15 Low

**Design flow 500 l/h (0,139 l/s)**

1. The design flow is used as the point of reference for the setting. (See the graph)
2. The pre-setting for the valve is found by means of the flow rate graph.  
Setting = 2.2
3. The minimum pressure drop required will be 11 kPa across the valve. ( $\Delta P_{V1}$ )

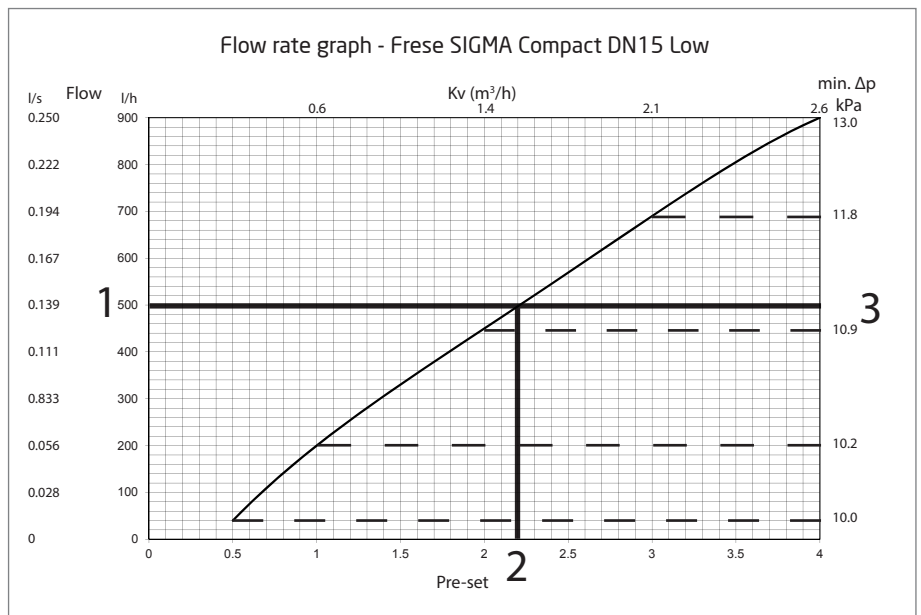

## Frese PV-SIGMA Compact Dynamic Pressure and Flow Regulation

Example: Outline of a heating system - 3 blocks with 3 flats in each

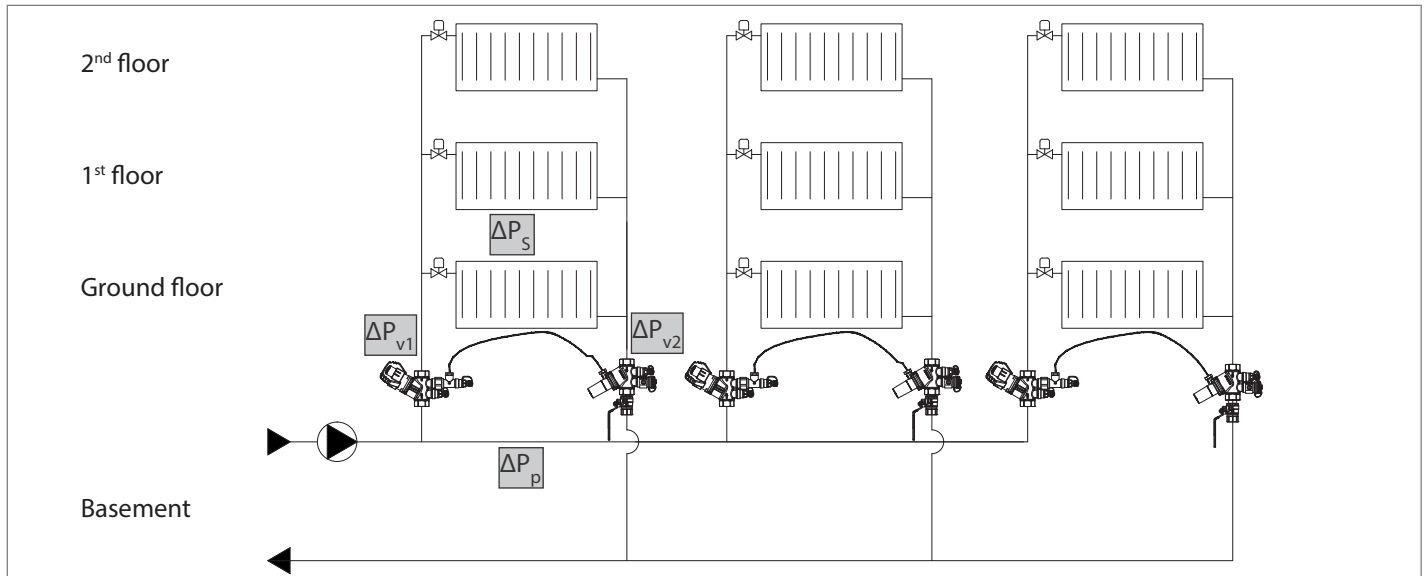

### Total pump pressure

From the examples on the previous pages, the total required pump pressure for the block can now be calculated:

$$\Delta P_p = \Delta P_s + (\Delta P_{v1+v2}) \rightarrow \Delta P_p = 12 \text{ kPa} + (11 \text{ kPa} + 3 \text{ kPa}) = \mathbf{26 \text{ kPa}}$$

### Example: Differential pressure change due to P-band

As the flow is reduced in the circuit in question the pressure increases in reverse ratio to the flow, which is due to the P-band of the adjustment spring.

The valve compensates for this, however the pressure will at no point in the circuit be as high as the pump pressure that would have been available, if Frese PV Compact had not been installed.

In this example the pressure increases to approx. 14 kPa as the graph is offset parallel to the course of flow. Furthermore, you can always read from the graph what the pressure in the circuit will be at any flow rate below the rated 500 l/h.

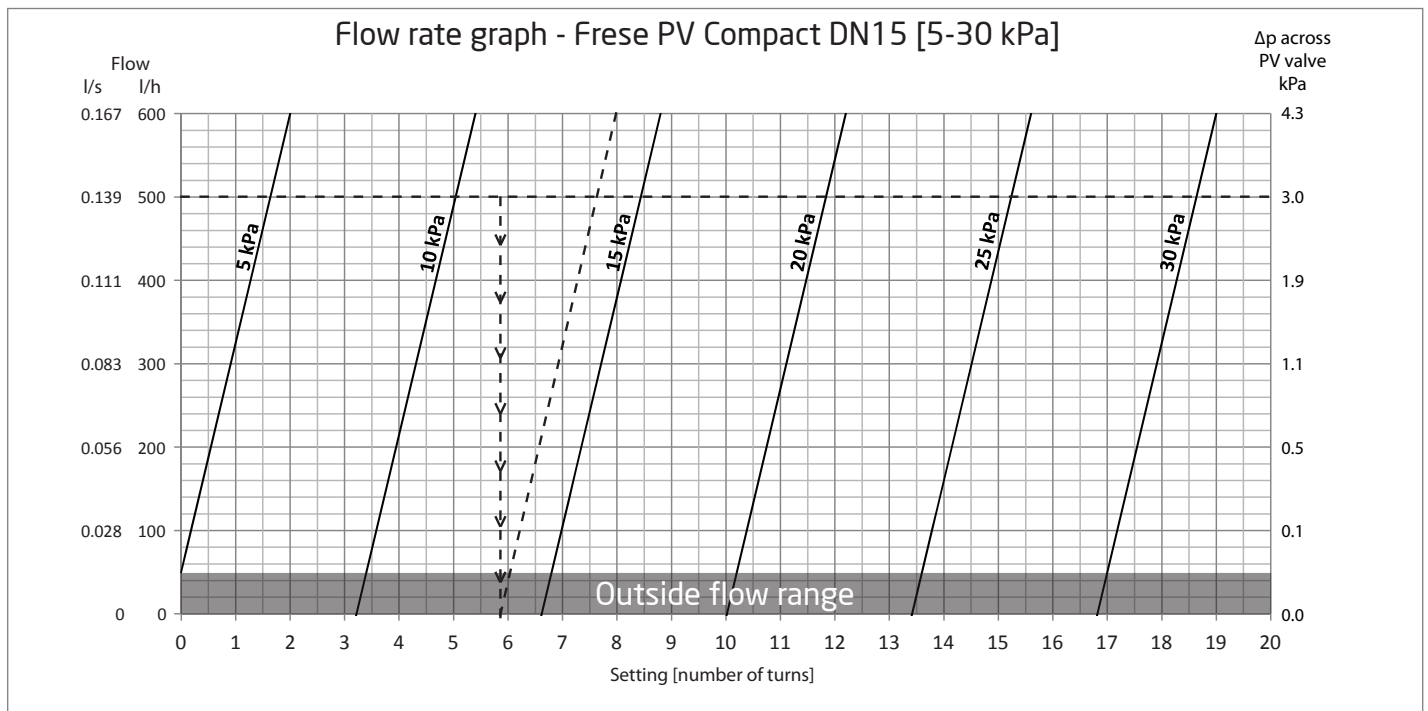

## Frese PV-SIGMA Compact Dynamic Pressure and Flow Regulation

### Frese PV Compact DN15, 5-30 kPa

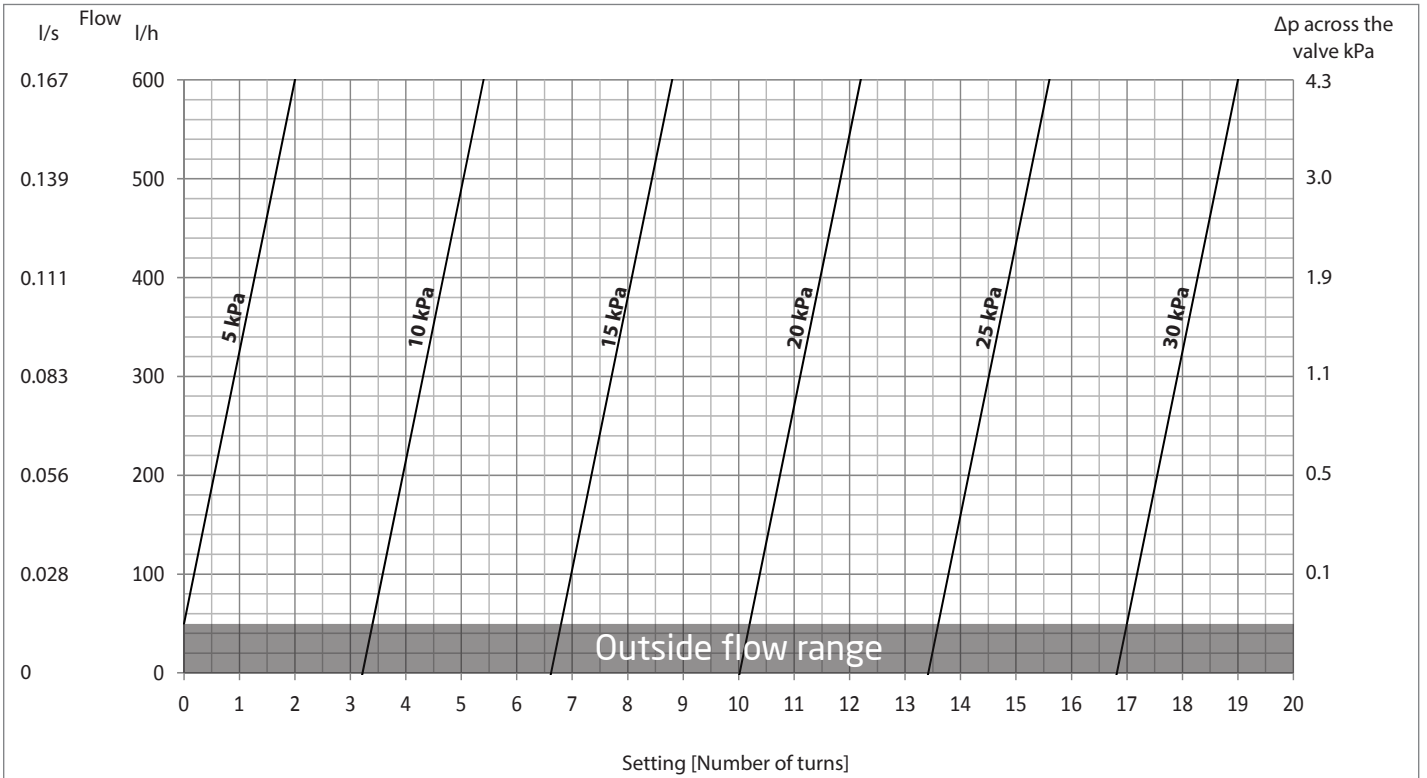

### Frese SIGMA Compact DN15 Low

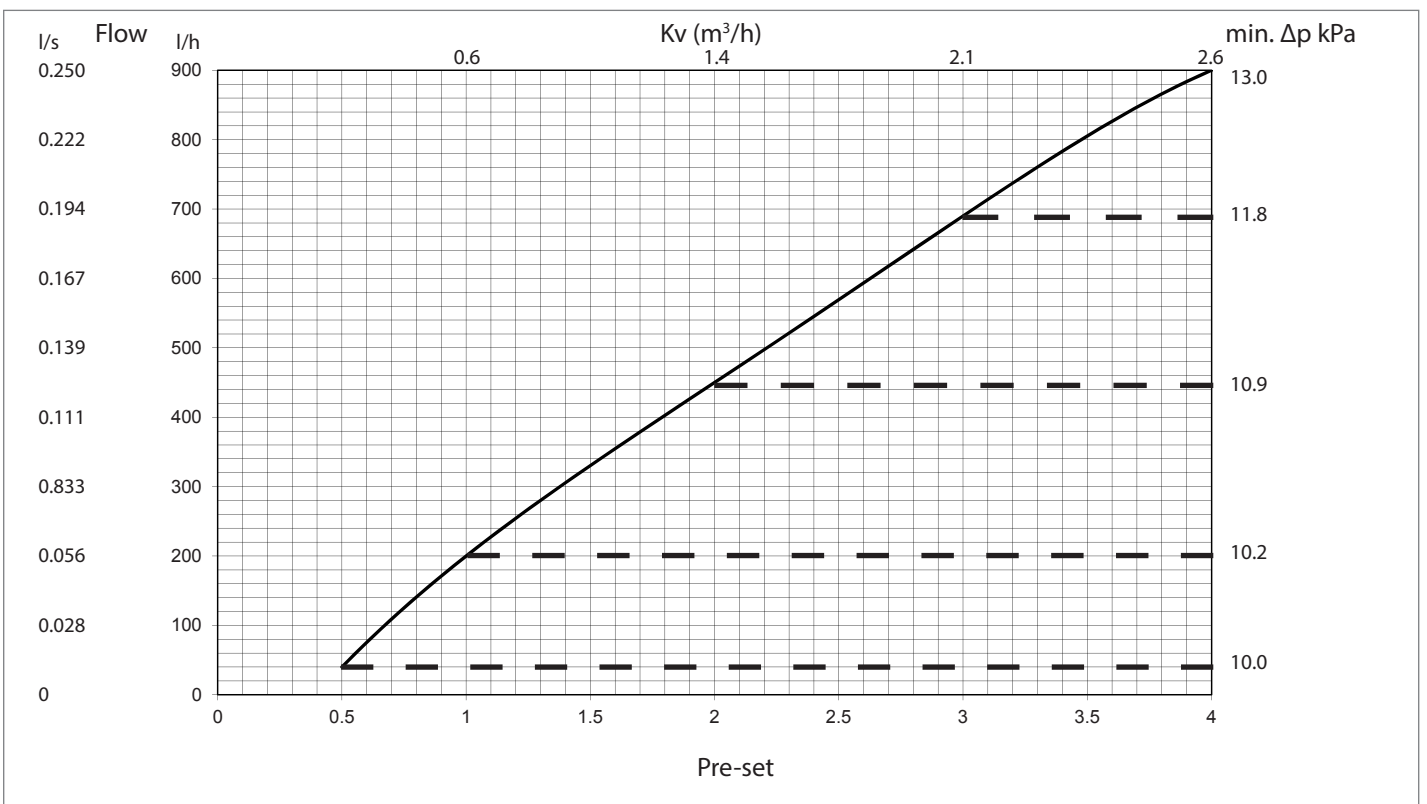

## Frese PV-SIGMA Compact Dynamic Pressure and Flow Regulation

### Frese PV Compact DN15, 20-60 kPa

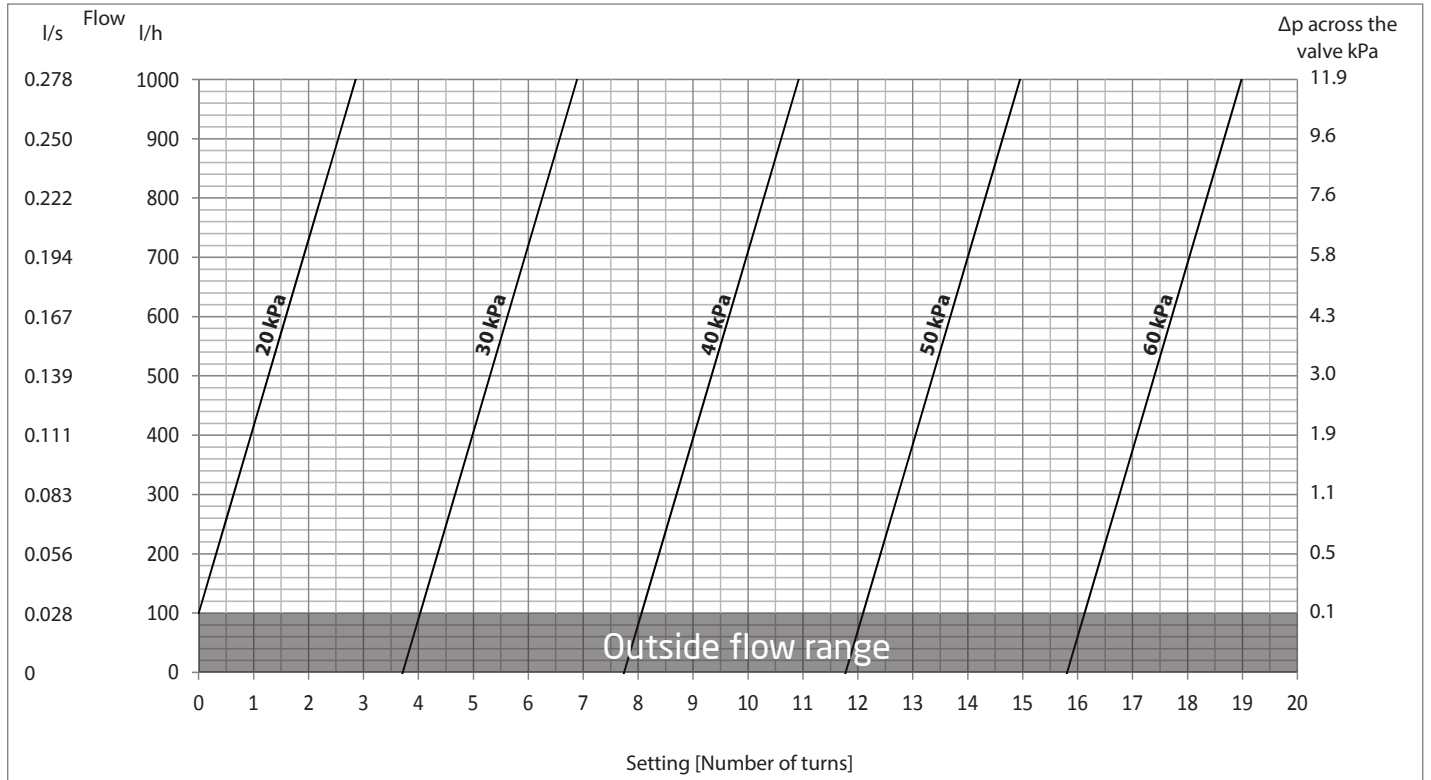

### Frese SIGMA Compact DN15 High

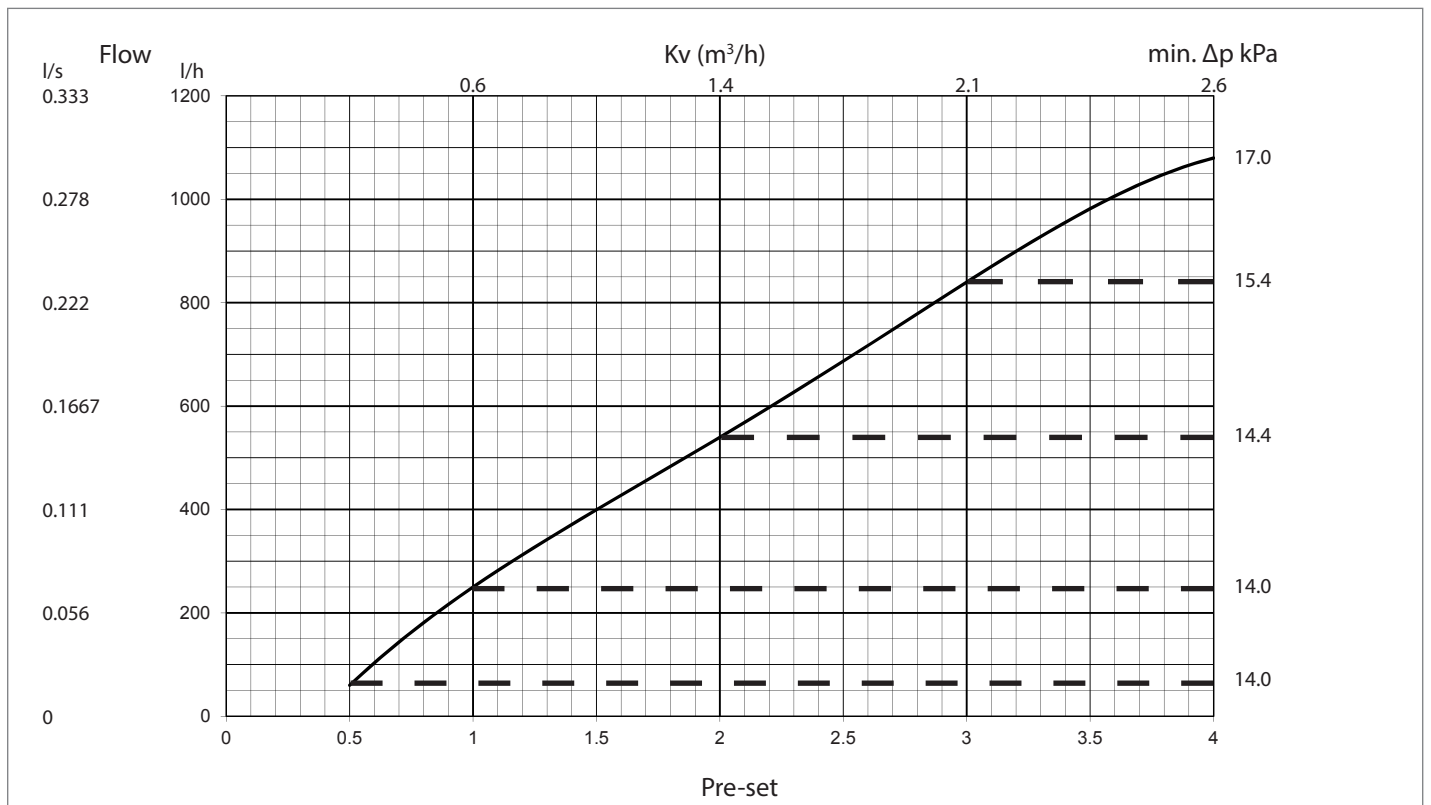



## Frese PV-SIGMA Compact Dynamic Pressure and Flow Regulation

### Frese PV Compact DN20, 5-30 kPa

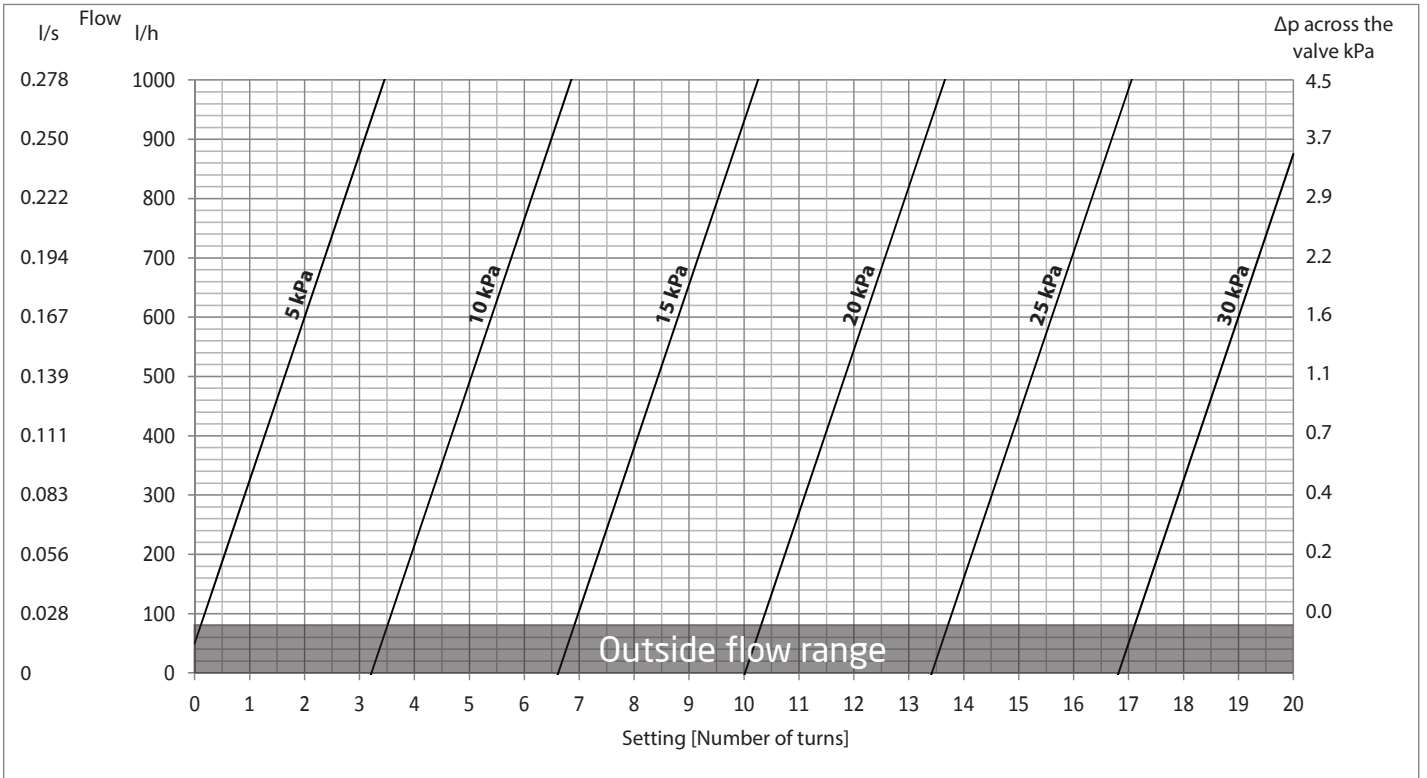

### Frese SIGMA Compact DN20 Low

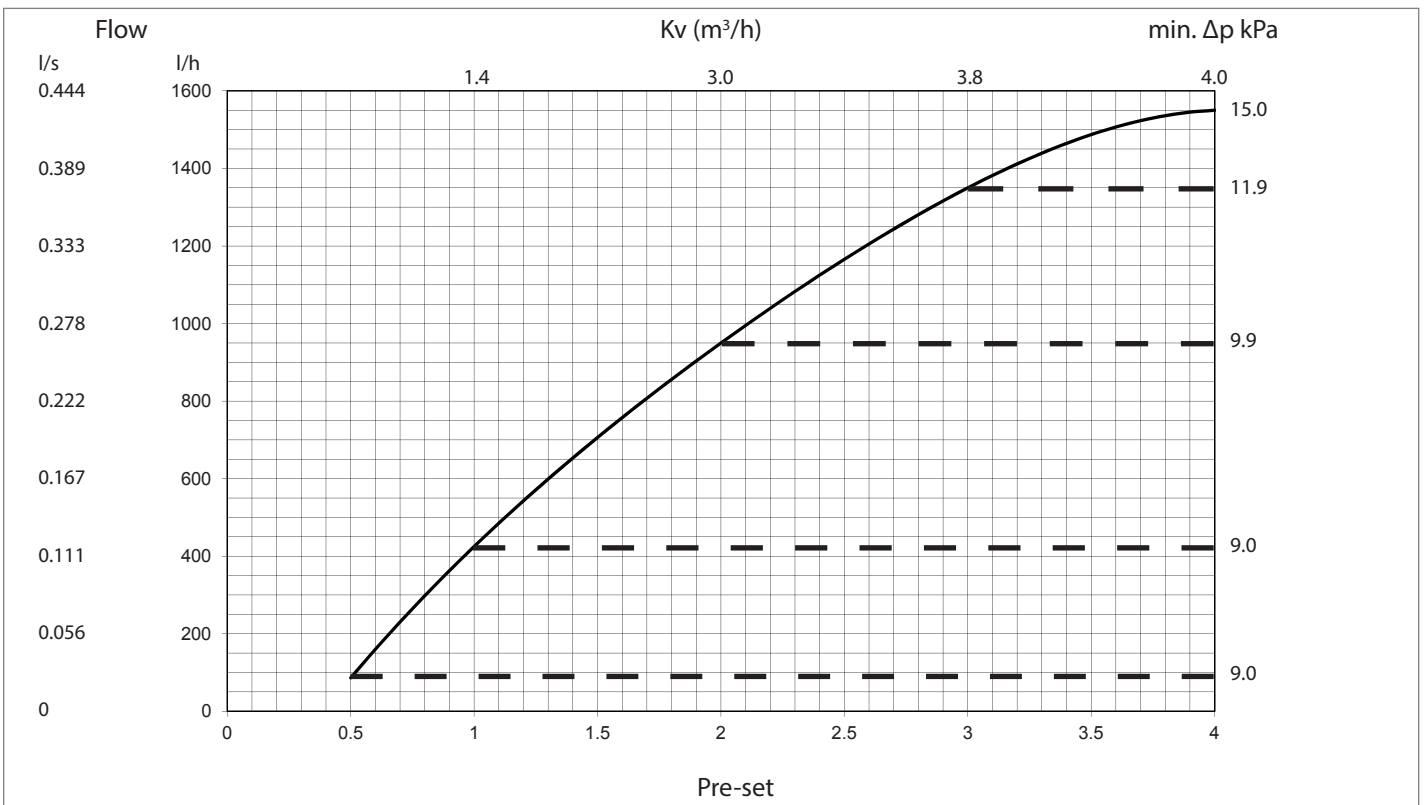

## Frese PV-SIGMA Compact Dynamic Pressure and Flow Regulation

### Frese PV Compact DN20, 20-60 kPa

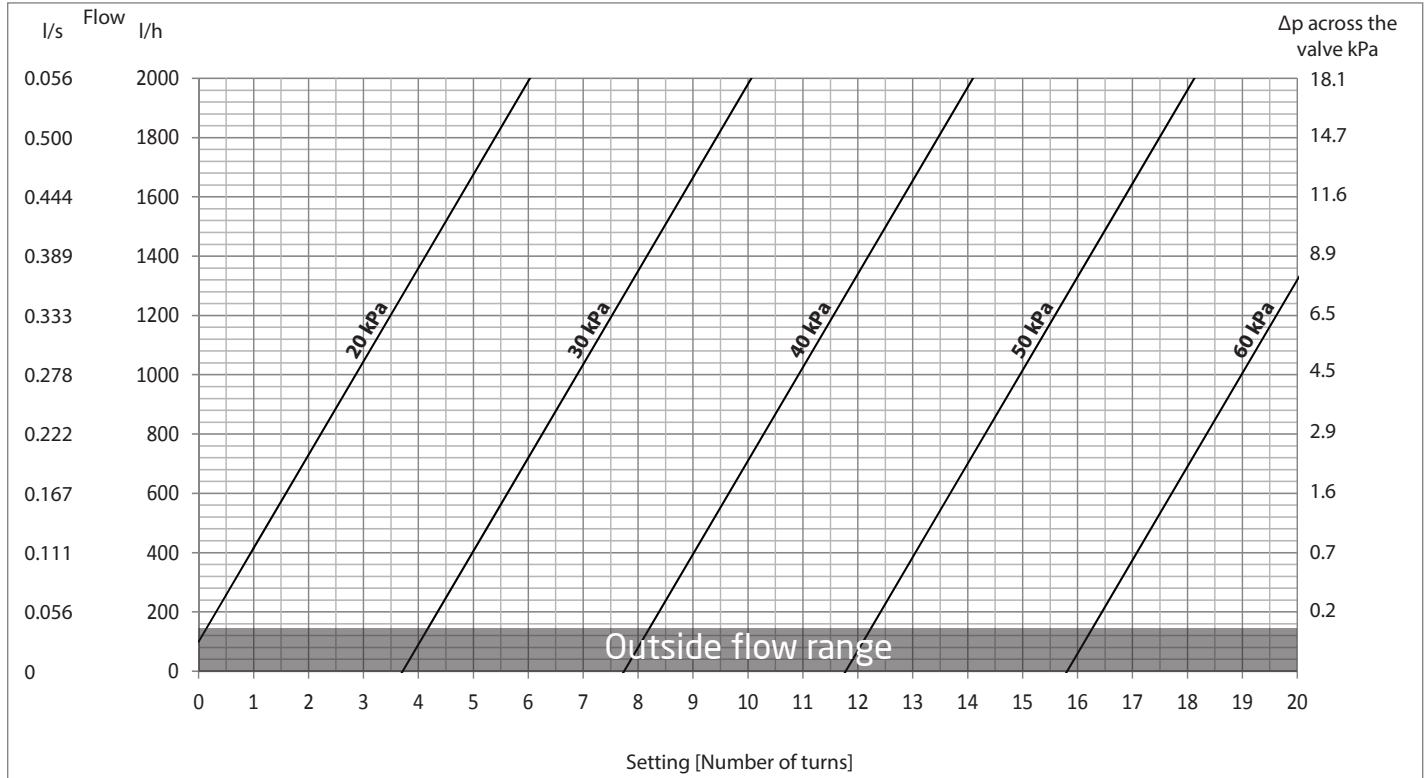

### Frese SIGMA Compact DN20 High

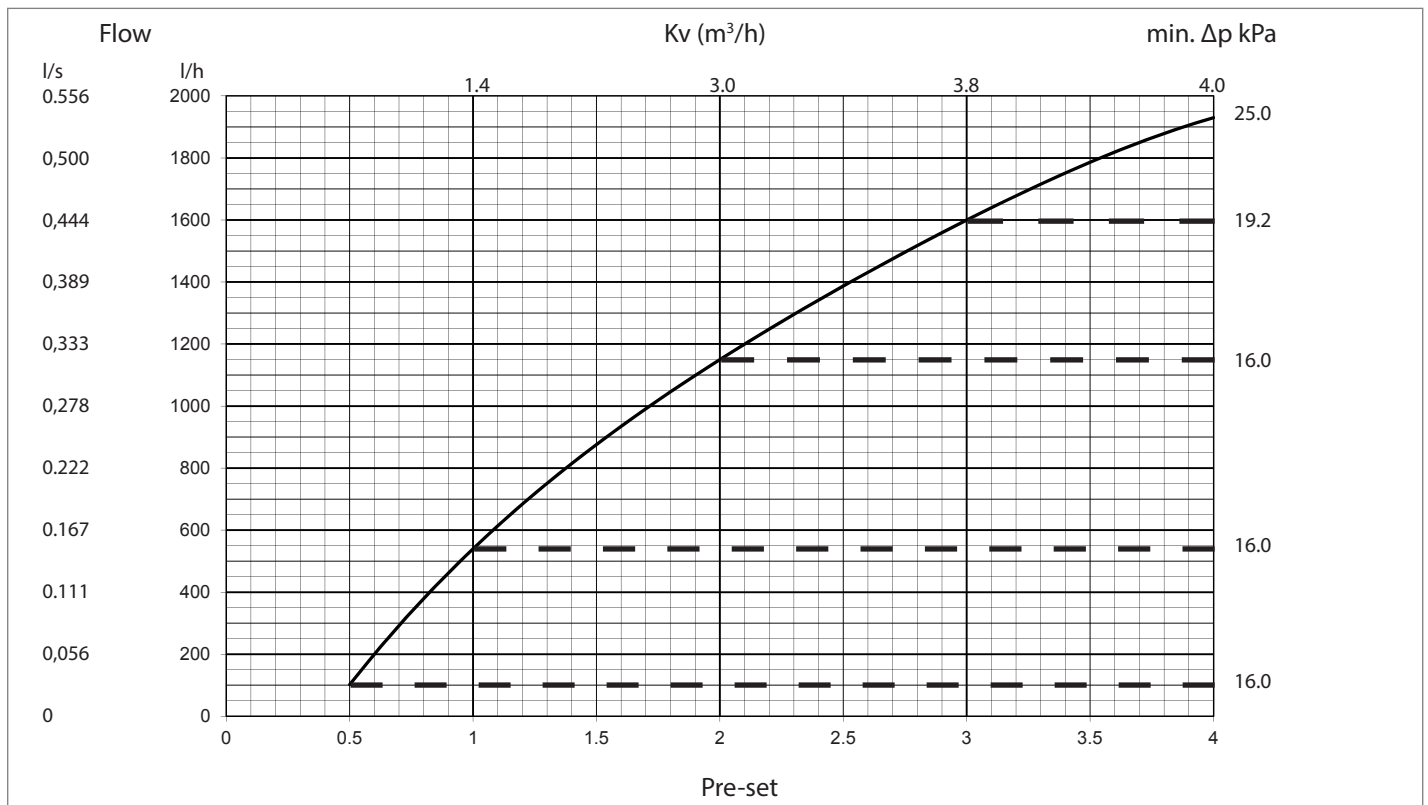

## Frese PV-SIGMA Compact Dynamic Pressure and Flow Regulation

### Frese PV Compact DN25, 5-30 kPa

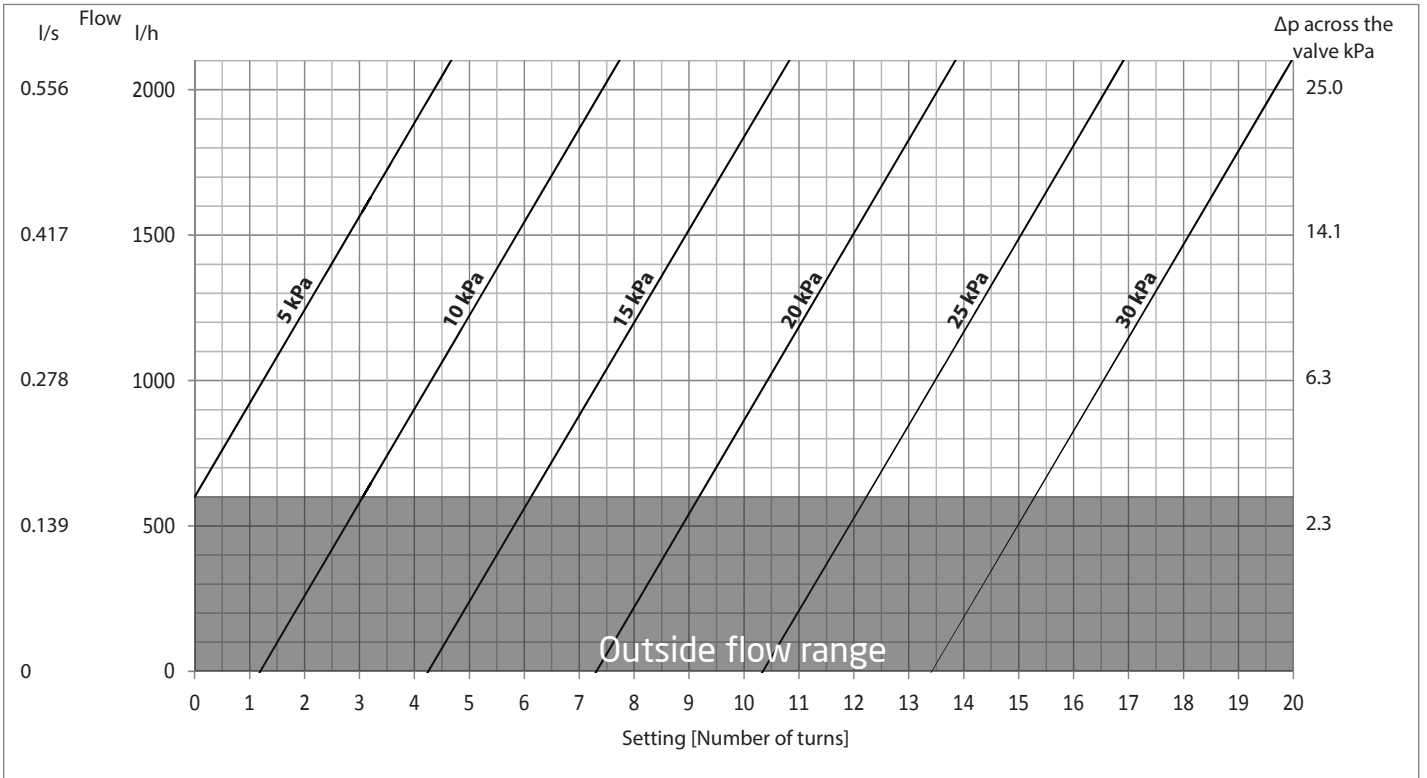

### Frese SIGMA Compact DN25 High

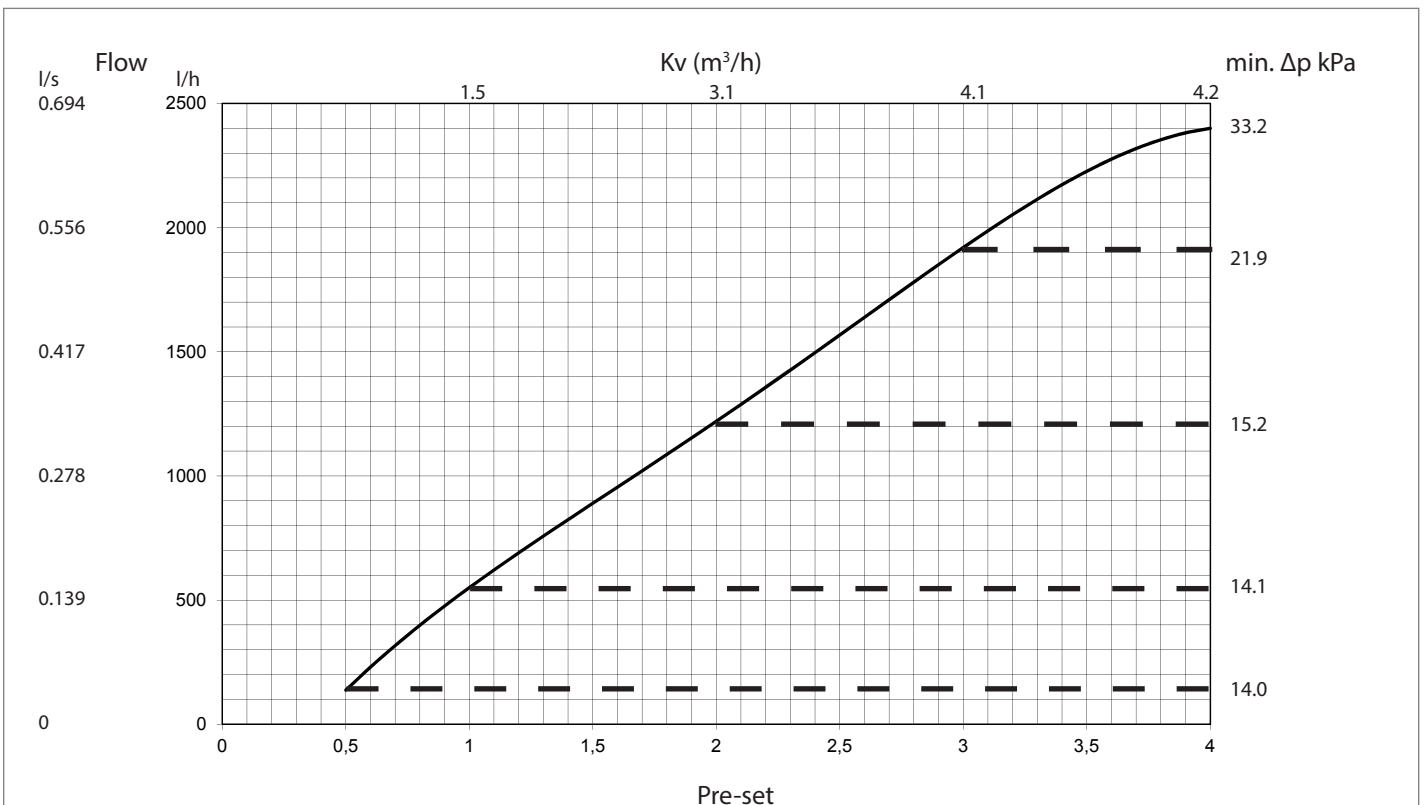

## Frese PV-SIGMA Compact Dynamic Pressure and Flow Regulation

### Frese PV Compact DN25L, 20-80 kPa

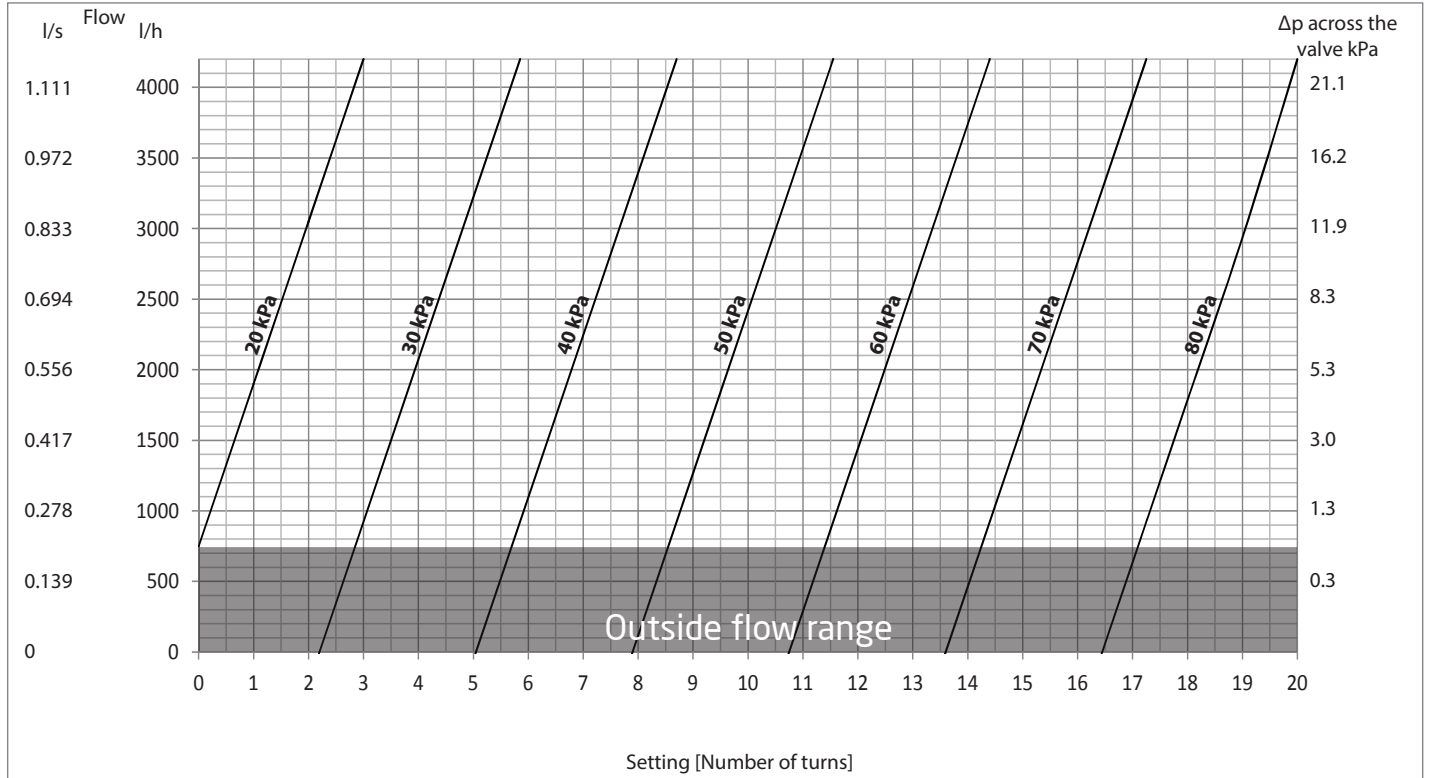

### Frese SIGMA Compact DN25 High

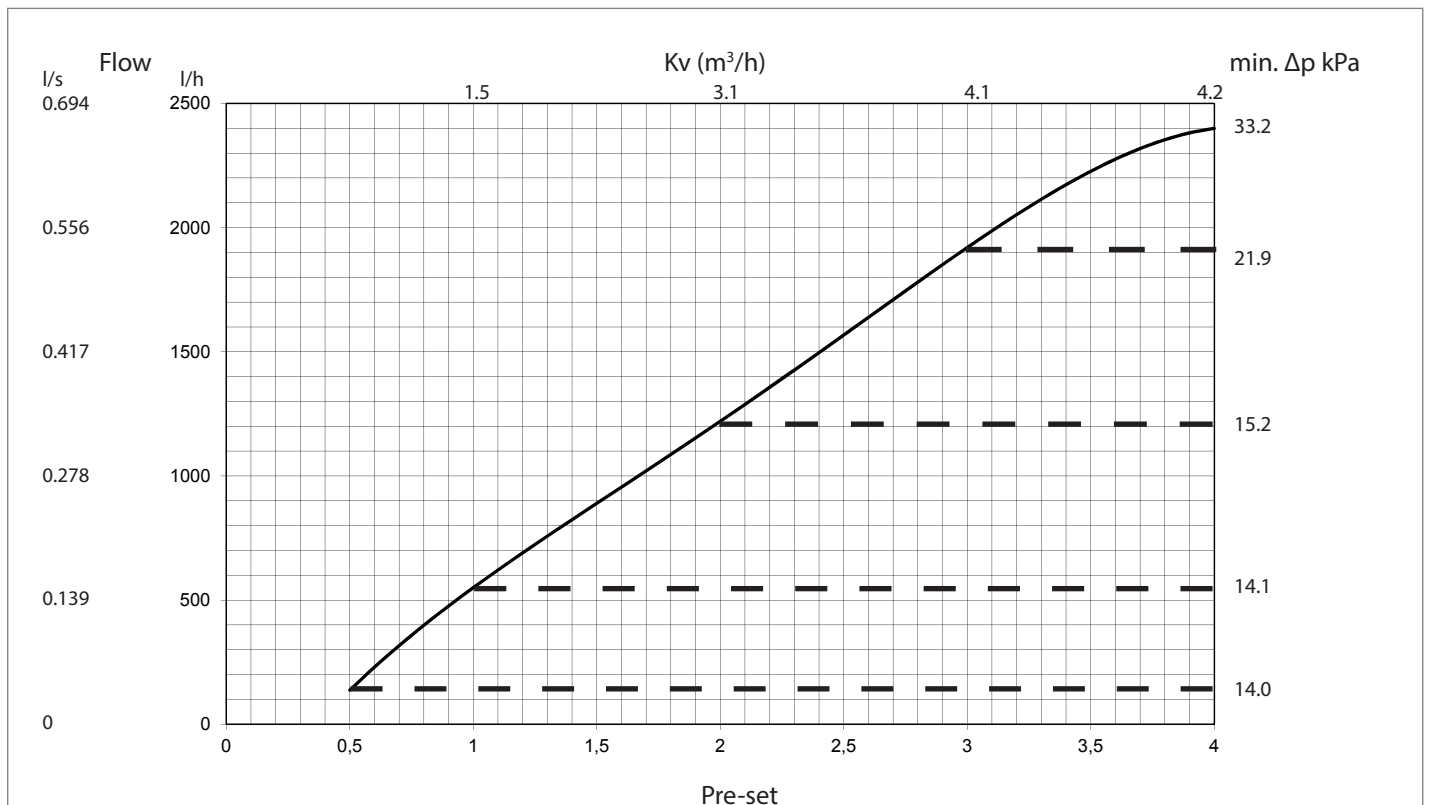

## Frese PV-SIGMA Compact Dynamic Pressure and Flow Regulation

### Frese PV Compact DN32, 20-80 kPa

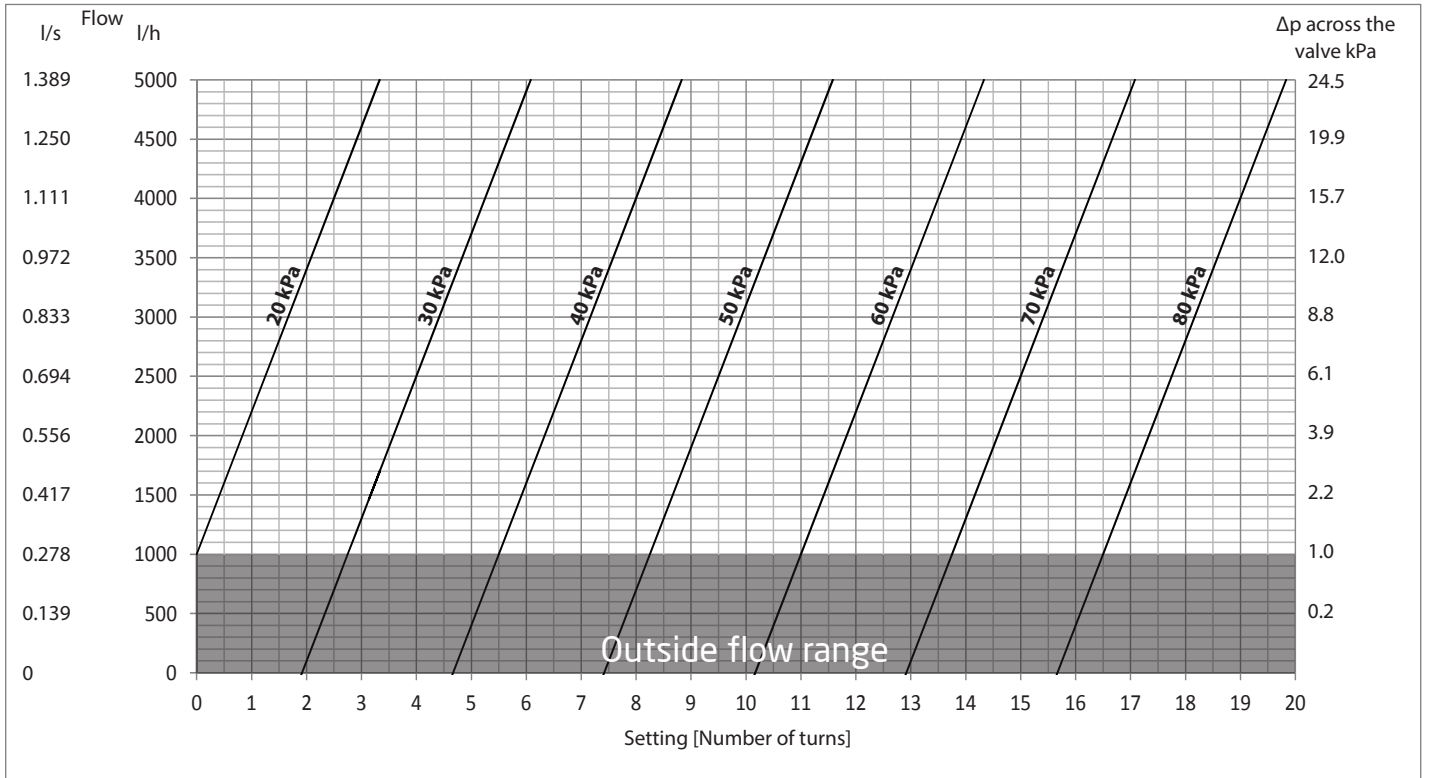

### Frese SIGMA Compact DN32

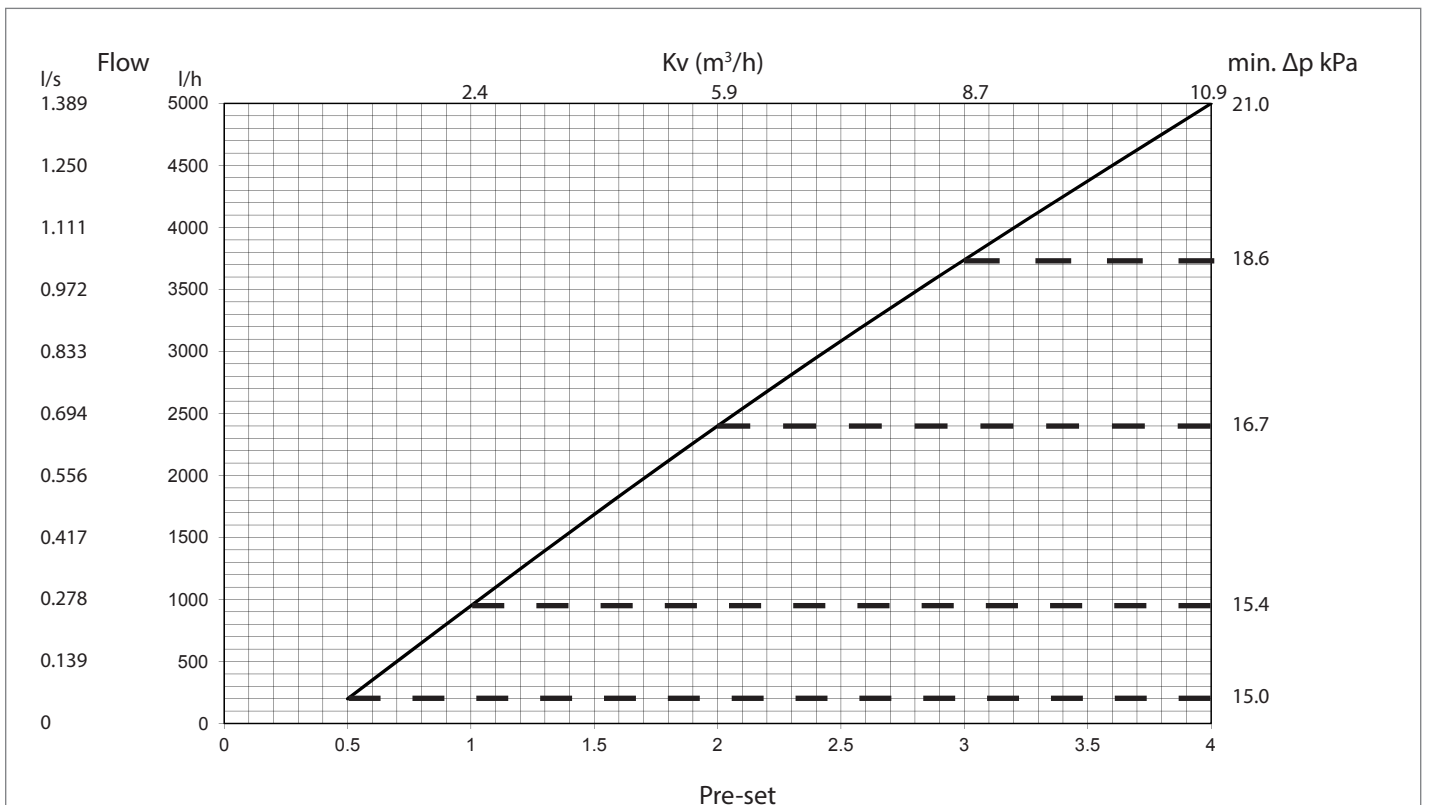

## Frese PV-SIGMA Compact Dynamic Pressure and Flow Regulation

### Frese PV Compact DN40, 20-80 kPa

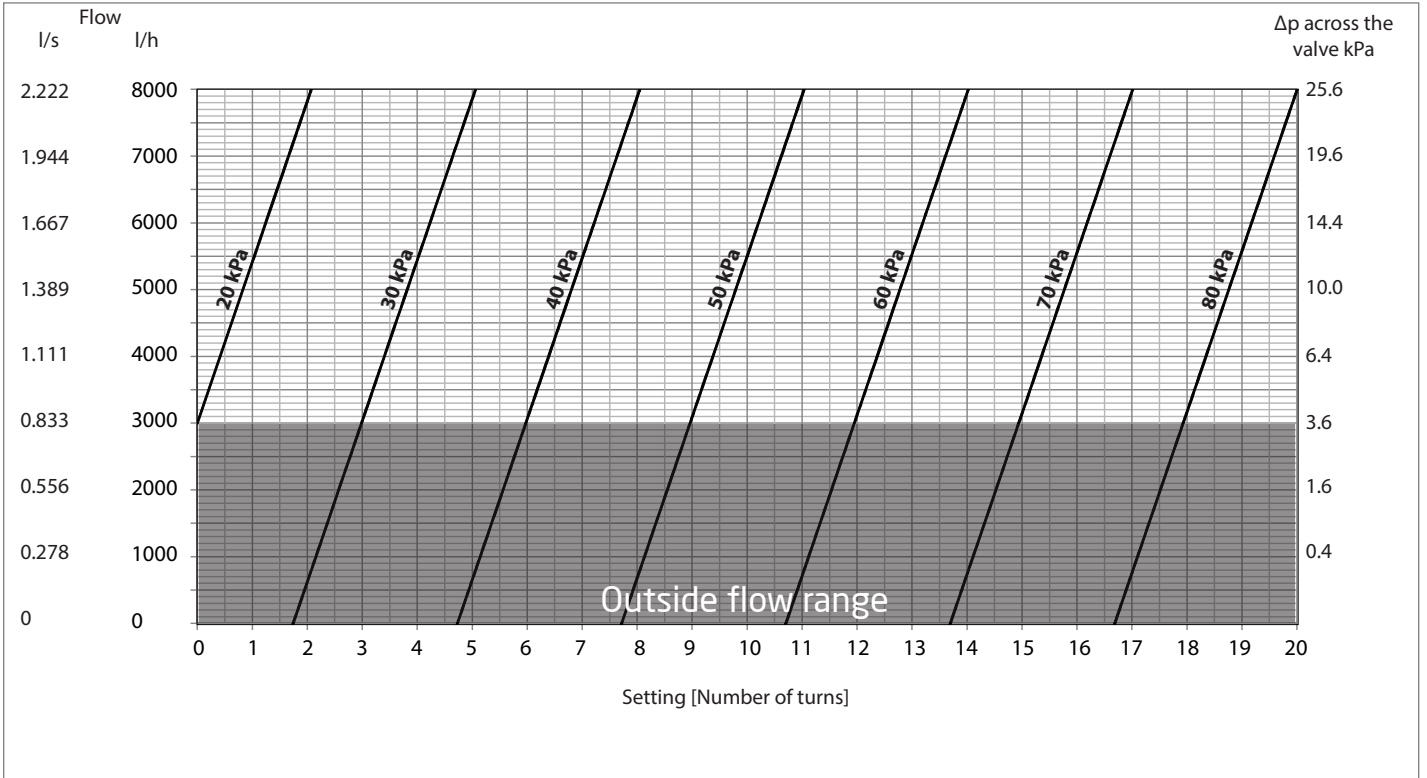

### Frese SIGMA Compact DN40

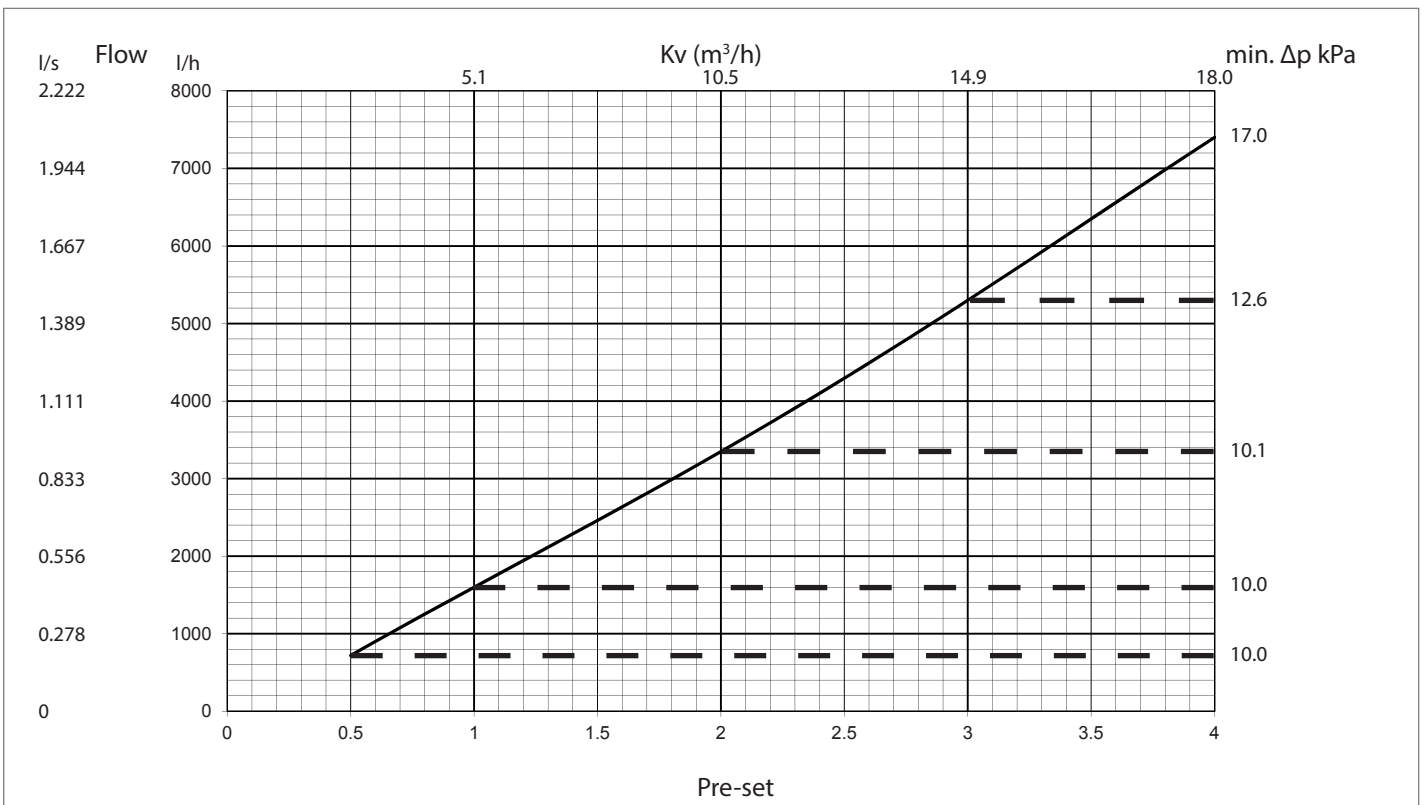

## Frese PV-SIGMA Compact Dynamic Pressure and Flow Regulation

### Frese PV Compact DN50, 20-80 kPa

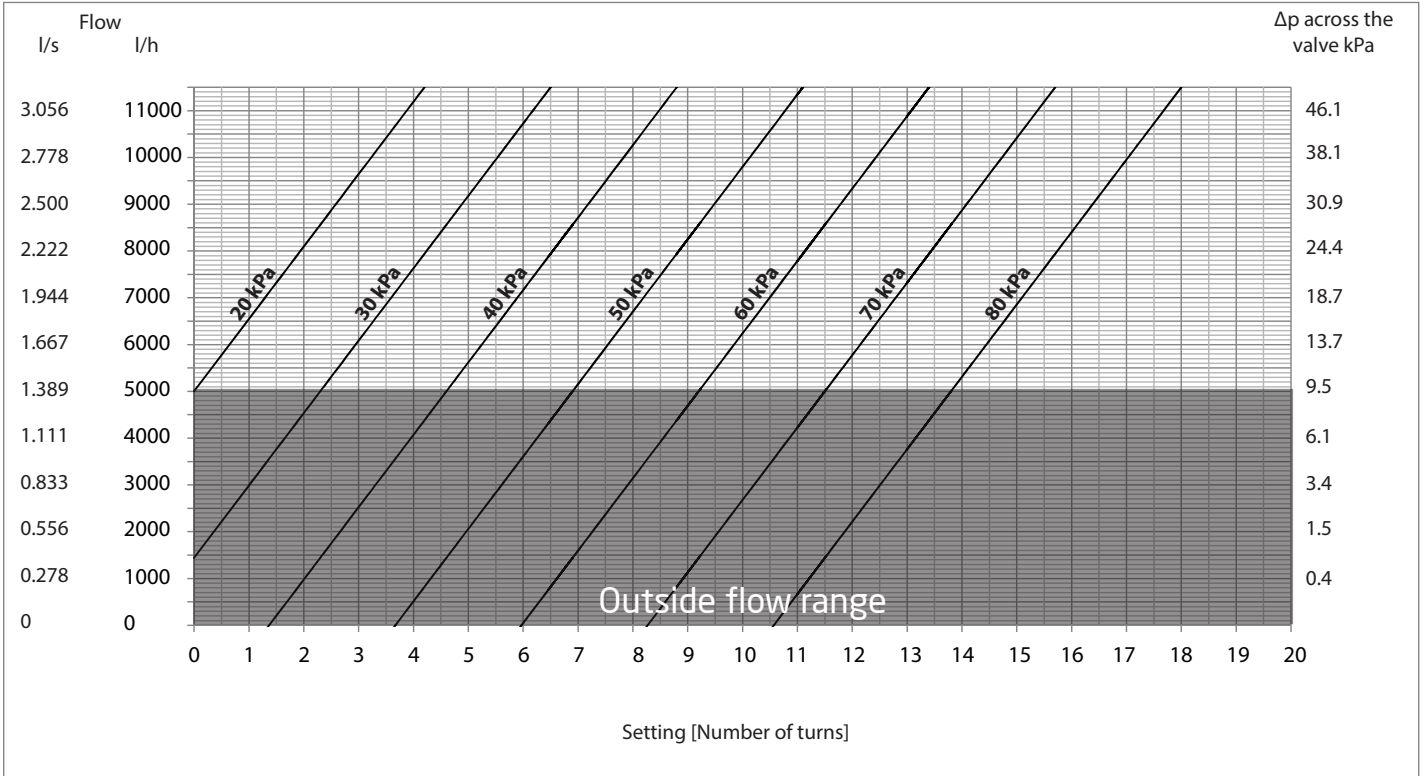

### Frese SIGMA Compact DN50

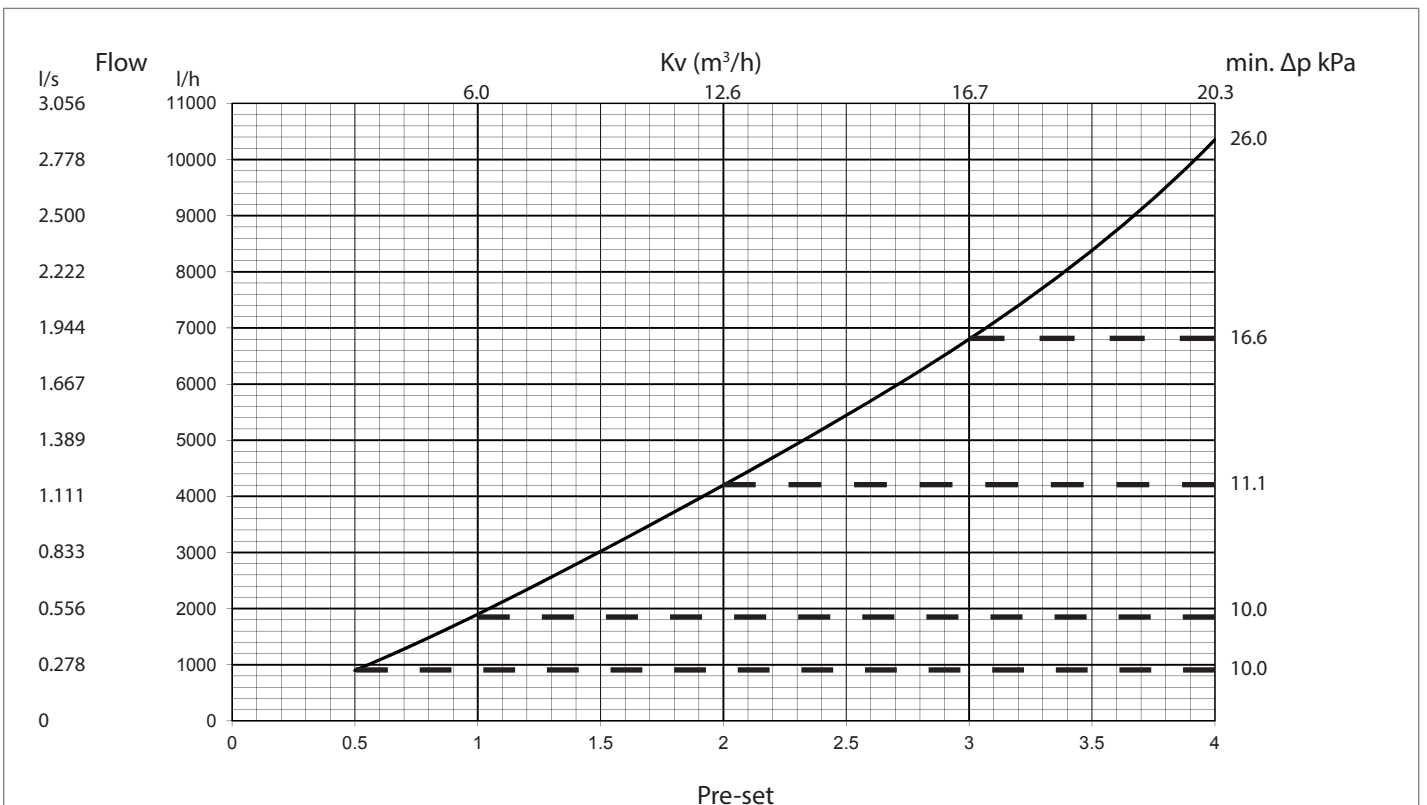

## Frese PV-SIGMA Compact Dynamic Pressure and Flow Regulation

---

### Specification Text - Frese PV-SIGMA Compact Dynamic Pressure & Flow Regulation Set

---

The valve set shall be a combination of a dynamic differential pressure control valve and an externally adjustable dynamic balancing valve.

The differential pressure and flow shall be adjustable on site without suspension of operation.

The valve set shall limit the flow and differential pressure in a circuit.

The valve set shall include P/T plugs for the verification of differential pressure in circuit and across the valve.

The valve set shall include a drain on the differential pressure control valve.

The differential pressure control valve scale shall only be adjustable by means of a key.

The dynamic balancing valve shall be adjusted by means of a lockable handle.

The dynamic balancing valve shall be capable of isolation in the flow direction.

The valves shall be permanently marked with an indicator for flow direction.

The dynamic pressure and flow regulation set shall have a pressure rating of PN25. Pressure rating PN16, when ball valve is used on the return.

The maximum differential pressure shall be 400 kPa.

The valve housing shall be DZR brass CW602N (DN15 to DN32) and Ductile Iron (DN40 to DN50).

The Differential Pressure Control Valve shall have a rubber seat to provide positive close off.

Frese A/S assumes no responsibility for errors, if any, in catalogues, brochures, and other printed matter. Frese A/S reserves the right to modify its products without prior notice, including already ordered products, if this does not alter existing specifications. All registered trademarks in this material are the property of Frese A/S. All rights reserved.

Frese A/S  
Sorøvej 8  
DK- 4200 Slagelse  
Tel: +45 58 56 00 00  
Fax: +45 58 56 00 91  
info@frese.dk